

TYPE-Q102-CA+

Guide to operation



Be sure to read all the following warnings and cautions before use.

IMPORTANT SAFTY PRECAUTIONS



This product has been designed and manufactured to assure personal safety. Improper use can result in fire, electric shock or injury to persons. Please read and observe all warnings instructions given in this operation manual.
Use your splicer only for its intended purpose.

◆ The meaning of these symbols
 In the product and this operation manual, symbols are used to highlight warnings and cautions for you to read so that accidents can be prevented. The meanings of these symbols are as follows:



○ **Symbol used in the product**

	This symbol, where it appears on the unit, indicates that hazardous voltage is present inside of the splicer.
---	---

○ **The meaning of these symbols**

	This symbol indicates a warning, caution, or danger and alerts you important instructions have been included on the product or in the manual.
	This symbol indicates actions that are prohibited.
	This symbol indicates actions that must be taken.

○ **The meaning of Warning and Caution**

 Warning	This symbol indicates explanations about extremely dangerous matters. If users ignore this symbol and handle the splicer the wrong way, serious injury such as fire or electric shock, or death could result.
 Caution	This symbol indicates explanations about dangerous matters. If users ignore this symbol and handle the splicer the wrong way, bodily injury and damage to the equipment could result.

Be sure to read all the following warnings and cautions before use.



<Setting up, transportation and using splicer>



	<ol style="list-style-type: none"> 1. This fusion splicer performs an arc discharge. Do not use the splicer in a hazardous location in which inflammable gas can generate or only electrical apparatus for explosive gas atmosphere can be used. 2. Never use spray cleaners such as Freon or Flammable gas on the splicer. Decomposition of arc by heat will cause toxic gas, or abnormal arc may result in damage or fire.
---	--





3. Do not use and store the splicer out of the locations defined in a brochure and this manual. Doing so can cause splicer malfunction or deterioration, resulting in fire or electric shock.
4. To reduce the risk of fire, electric shock or malfunction, do not allow the splicer to be exposed to rain and get liquid such as water or a metallic object inside the splicer. Doing so can cause fire, electric shock or malfunction by shorting out internal components.
5. Never use the battery pack, AC adapter and battery charger, and power cables for the machines other than the specified splicer. Doing so can cause these items to damage, resulting in fire or heat generation.
6. Do not make mechanical or electrical modifications to the splicer since this may expose you to dangerous voltage or other hazards.
7. Do not touch the electrodes during and after arc discharge. Doing so can cause personal injury or electric shock.
8. The heating plate of the heat shrink oven may be hot during heating. Do not touch the protection sleeve directly after heating. Doing so can cause burn. A protection sleeve may also be hot after heating. Handle with care.
9. Do not operate the splicer in the rain. Doing so can cause AC adapter or battery pack to be short-circuited.
10. Do not expose the splicer to extremely high temperature and high humidity or to direct sunlight for prolonged periods.
11. Do not continuously use the heat shrink oven for long hours, keeping it high temperature. Doing so can cause heat shrink oven to malfunction.
The following case is the exception for repairing and replacing the product free of charge:
The Heating duration is set to a long time (e.g. 180 sec.) and the Finish temperature is set to a high temperature (e.g. 200 °C). The heat shrink oven is used for long hours by continuing to press the Heat key shortly after the heat cycle is completed.
12. Only use alcohol to clean the splicer. To prevent malfunction and damage, do not use any other kind of chemicals.
13. Never use spray cleaners such as Freon or flammable gas on the splicer. Heat by arc can cause gas component to produce a chemical reaction, which will deteriorate a microscope lens, resulting in a loss of splicing capability.
14. Parts that compose the heat shrink ovens might become high temperatures. When those parts are damaged, do not use it and contact our service center.
15. Because it is likely to injure by shards of glass when the monitor is damaged, do not use it and contact our service center.
16. When parts that compose this product and the accessory (battery pack, AC adapter, and power cord, etc.) are damaged, do not use it and contact our service center.
17. If this product gets wet with dew or the like, do not turn it on.
18. Do not use this product near the electronic equipment that handles a highly accurate control and the faint signal such as the heart pacer. The influence of the miss-operation of electronic equipment might be given.
19. Alcohol is prohibited on air transportation. Empty alcohol dispenser before transportation.

	<p>20. Avoid places with too much dust or dirt. Dirt or dust that can accumulate in the fusion splicer causes short circuit and insufficient cooling, which may lead to splicer malfunction or deterioration, resulting in fire or electric shock.</p> <p>21. Only use the battery pack, AC adapter, battery charger and power supply cord for the splicer as defined in this manual. Failure to do so can cause these items or the fusion splicer to damage, resulting in fire or electric shock.</p> <p>22. Only use a voltage within the indicated power voltage. Failure to do so can cause fire or electric shock.</p> <p>23. Check for condensation before operation. If this product gets wet with dew or the like, leave it in a room temperature for about one day before turning it on. If water or other liquid, a metallic object or other foreign substance gets inside the splicer, immediately turn off the power and disconnect the power plug. Contact our qualified service personnel.</p> <p>24. In a high location, take safety measures to prevent fall of operators. Dropping the splicer could result in personal injury. Fix the splicer to a worktable or a tripod with the screw on the bottom of the splicer.</p> <p>25. If an abnormal condition such as unusual noise, smoke or unusual odor occurs, immediately turn off the power and disconnect the power plug. Next, contact our qualified service personnel.</p> <p>26. Be sure to turn off the splicer and unplug the power cord or remove the battery pack before replacing the electrodes.</p> <p>27. Only use Sumitomo genuine electrodes (ER-10). And use the splicer with electrodes installed in it. Failure to do so can cause the splicer to damage, resulting in fire, electric shock or malfunction.</p> <p>28. If the heat shrink oven keeps running for a prolonged time, the surrounding parts may become hot. Pay attention to the heat particularly in a high temperature environment and use protective gloves as needed.</p> <p>29. The supplied alcohol dispenser is not an airtight container. Pour alcohol into an airtight container before transportation, so it does not spill out.</p>
---	---

<Handling of power cord and plug >

	<p>1. To reduce the risk of electric shock, do not plug/unplug the power cord or remove the battery pack with wet hands.</p>
	<p>2. Disconnect the power cord by grasping the plug, not the cord. Failure to do so can cause damage to the power cord, resulting in fire, electric shock or malfunction.</p> <p>3. Before charging the battery pack, make sure that the pins of the battery charge cord are not bent or broken. Using the battery charge cord with a bent or broken pin can cause internal short circuit, resulting in fire or electric shock.</p>

<Handling of battery pack>



	<ol style="list-style-type: none">1. Do not burn the battery pack or throw it into a fire. Doing so can cause heat generation, bursting and fire.2. Do not place the battery pack in microwave ovens and high-pressure containers.3. Do not let water or sea water wet or soak the battery pack. Safety and protective devices to prevent danger are built in the battery pack. If these devices are damaged, excessive current flow can cause abnormal chemical reaction in battery fluid, heat generation, bursting and fire.4. Do not throw or impact the battery pack. Safety and protective devices to prevent danger are built in the battery pack. If these devices are damaged, excessive current flow can cause abnormal chemical reaction in battery fluid, heat generation, bursting and fire.5. Do not pierce the battery pack with nails, strike the battery pack with a hammer, or step on the battery pack. Doing so can cause internal short circuit, heat generation, bursting and fire.6. Do not disassemble or modify the battery pack. Safety and protective devices to prevent danger are built in the battery pack. If these devices are damaged, excessive current flow can cause loss of control during charging or discharging of the battery pack, heat generation, bursting and fire.7. Make sure the polarities are correctly connected. Do not attempt to connect the battery pack or other equipment when you cannot do. Reversed connections can cause abnormal chemical reaction in battery fluid, heat generation, bursting and fire.8. Do not solder any lead wires directly to the battery pack. Do not directly connect the positive and negative terminals with a conductive material such as a wire. Do not carry or store the battery pack together with any personal jewelry, hairpins or other Metallic objects. Doing so can cause an electrical short circuit. Also excessive current flow can cause abnormal chemical reaction in battery, heat generation, bursting and fire.
	<ol style="list-style-type: none">9. Only use a specified battery charger. Failure to do so can cause the battery to be overcharged or excessive current flow can cause abnormal chemical reaction in battery fluid, heat generation, bursting and fire.10. Use the battery pack only for the application for which it was designed. Failure to do so will result in a loss of performance and a shortened life expectancy. Also excessive current flow can cause loss of control during charging or discharging of the battery pack heat generation, bursting and fire.





<Transportation and storage>

	<ol style="list-style-type: none">1. This product is a precision instrument. When transporting the splicer, use its specified carrying case to protect the splicer from excessive shock or impact.2. Do not use and store the splicer out of the locations defined in a brochure and this manual. Failure to do so can cause splicer malfunction or deterioration, resulting in fire or electric shock.3. Do not store any items other than the product, package contents and optional accessories in the carrying case. Overloading the case can cause damage to the body of the carrying case, case handle, strap and latch.4. Do not throw or fall the carrying case. Doing so can cause damage to the body of the carrying case, case handle, strap and latch.5. Do not use a carrying case where there is a visible sign of damage and screw looseness.6. Do not store the hand strap in the windshield. It causes damage to the machine.7. Do not carry the machine grabbing the hood or the monitor.8. Do not brandish the machine with the hand strap, and brandish neither AC adapter nor the power cord. There are fear of machine damage and the injury.9. Do not use the machine with the lid of the battery Pack slot opened.
	<ol style="list-style-type: none">10. When shipping this product, inform the transport company that this product contains the lithium-Ion battery. Follow the direction of the transport company.11. Before carrying the case, make sure that there is no visible sign of damage and screw looseness on the handle and latch. If the case with damage and screw looseness is carried, it could drop down, causing personal injury or splicer malfunction.12. Before picking up the case, ensure that the latch is completely locked. Carrying the case with the latch unlocked can cause the case to fall open and result in personal injury or splicer malfunction due to heavy impact.13. Be careful that your fingers not to be caught in the hinge part and the lid when you open and shut the case.14. Confirm the work table of the carrying case is surely fixed to the case when you carry it.15. Do not modify the handle, strap or strap attachment points. Only use the carrying strap supplied by us.16. Avoid places with too much dust or dirt. Dirt or dust that can accumulate in the fusion splicer causes short circuit and insufficient cooling, which may lead to splicer malfunction or deterioration, resulting in fire or electric shock.17. If you are not going to use the splicer, remove the battery pack from the splicer. Failure to do so will shorten a battery life.18. Unplug the fusion splicer or remove the battery pack before attempting any maintenance or if not using the splicer for a prolonged period. Failure to do so can cause fire.19. The monitor, the hood, and the heater clamping, etc. do the opening and shutting operation. Be careful of your fingers not to be caught.

<Battery handling and charging>

	<ol style="list-style-type: none"> 1. Make sure the polarities are correctly connected. Do not attempt to connect the battery pack or other equipment when you cannot do. Reversed connections can cause abnormal chemical reaction in battery fluid, heat generation, bursting and fire. 2. Do not carry or store the battery pack together with any personal jewelry, hairpins or other Metallic objects. Doing so can cause an electrical short circuit. Also excessive current flow can cause abnormal chemical reaction in battery fluid, heat generation, bursting and fire. 3. Do not use a dry cell battery and the batteries differing in capacity, type, and manufacturer. Doing so can cause heat generation, bursting and fire.
	<ol style="list-style-type: none"> 4. The battery's optimum charging temperature range is 0 to 40°C. Under high temperature conditions such as in direct sunlight or near a fire, safety and protective devices to prevent danger which are built in the battery pack will be activated, resulting in failure of charging. Or if these devices are damaged, excessive current flow can cause loss of control during charging or discharging of the battery pack, heat generation, bursting and fire. Avoid charging the battery pack at extremely low temperature (below 0°C). Failure to do so may lead to deterioration in performance and battery leakage. 5. Always turn off the power to the splicer after use. Failure to do so can cause the battery to be over discharged and deteriorated in performance. 6. In the event the fluid inside the battery leaks, take extremely care not to expose it to your eyes and skin. If it does, immediately wash them thoroughly with clean water enough from the tap and consult a doctor urgently. 7. Unplug the fusion splicer or remove the battery pack before attempting any maintenance or if not using the splicer for a prolonged period. Failure to do so can cause fire. 8. Pay attention not to drop the battery pack when installing and removing it. Dropping the battery pack can cause personal injury.

<Handling of optical fiber >

	<ol style="list-style-type: none"> 1. Never look into optical fibers or the end of an optical cable attached to the optical output when the device is active. The laser radiation can seriously damage your eyesight.
	<ol style="list-style-type: none"> 2. Wear safety glasses at all times for protection from glass fibers.

< Others >

	<ol style="list-style-type: none"> 1. Do not press the keys on the keypad with a sharp object (e.g. a ballpoint pen, screwdriver, or nail) Doing so will damage the keypad. 2. Do not press strongly the touch screen with a sharp object. 3. Do not use or store the battery pack at high temperature, such as in strong direct sunlight, and in cars during hot weather. This can cause deterioration of the battery. 4. Do not press the liquid crystal display with force or the display may fail. 5. Take care to keep spliced fiber straight. Do not flex it back and forth. Doing so can cause the spliced fiber to be broken, resulting in loss of the long term reliability of the fiber. 6. Do not use a canned air for cleaning. Chemical reaction may deteriorate the lens, resulting in a loss of splicing capability.
---	---



7. Check the voltage of AC power before use. The AC adapter should be grounded to earth. If voltage or frequency beyond the range stated flows in the AC adapter, a safety and protective device to prevent danger is activated and the AC adapter will stop. In that case, a new AC adapter should be purchased. Please contact our qualified service personnel.
8. Charge the battery pack within the following temperature range. Failure to do so may lead to deterioration in performance.
*Battery pack's required temperature range: 0°C ~ +40°C
9. Before using the battery pack for the first time, charge it.
10. The battery pack is consumables. Repeated charging and discharging decreases battery life.
11. Store the battery pack within the following temperature range. Failure to do so may lead to deterioration in performance.
*Battery pack storage temperature range: -20°C ~ +50°C (if stored for less than 1 months) -20°C ~ +40°C (if stored for less than 3 months) -20°C ~ +20°C (if stored for less than 1 year)
12. Charge the battery pack fully before storing it for a prolonged period.
13. Even if you are not going to use the battery pack for a prolonged period, charge it once every 6months.
14. If you are getting fewer than splice cycles per fully charged battery, consider replacing the battery pack by a new one.
15. When disposing of the battery pack, contact our qualified service personnel or follow the local regulations.
16. Although bright spots or dark spots may appear on the screen, this is a unique characteristic of liquid crystal displays, and such do not constitute or imply a machine defect.
17. We recommend your splicer to be annually over-hauled to keep it in good condition.
18. Glass fiber fragments are extremely sharp. Handle with care.
19. Turn off the splicer before maintenance work. Failure to do so can cause electric shock.
20. Be sure to remove moisture, alcohol or dust on the heater element with a dry cotton swab.
21. Only use Sumitomo genuine electrodes (ER-10). Failure to do so can cause the splicer to malfunction.
22. Do not clean the electrode. Doing so can cause unstable arcing performance.
23. Storing and transporting the splicer with the battery pack installed can cause the battery pack to be damaged or deteriorated, resulting in fire. Remove the battery pack from the splicer before storage.
24. Transporting the splicer with fiber holders loaded can cause the V-grooves or clamps to be damaged, resulting in the failure of splice. Remove the fiber holders from the splicer before storage.
25. Ensure that the strap should be completely secured.
26. Whenever you use the strap rings, be sure to hold the splicer with your hand. Failure to do so can cause the splicer to turn over and accessories such as fiber holder will drop.

RoHS Directive (2011/65/EU)

The TYPE-Q102-CA+ optical fusion splicer is RoHS-compliant.

WEEE Directive (Waste Electrical and Electronic Equipment; 2002/96/EC)

The European Union has enacted a Directive 2002/96/EC on Waste Electrical and Electronic Equipment (WEEE Directive). This directive is applicable in the European Union member states. The crossed out wheellie bin symbol found on our products indicates that it should not be disposed of together with household waste. To prevent possible harm to human health and the environment, waste electrical equipment must be disposed of in an approved and environmentally safe recycling process.



For further information on how to dispose of the product correctly, please contact the product supplier, or the local authority responsible for waste disposal in your area.

IMPORTANT: REGION LIMITATION

WARNING:

This product is sold for the use in a limited sales area and the sale, resale, transfer, lease or otherwise of this product to the other regions is prohibited, except written consent of Sumitomo Electric Industries, LTD.

YOU NEED TO AGREE ABOUT A SOFTWARE LICENCE AND REGION LIMITATION BEFORE USE.

Reference of Sales Area and Sumitomo Sales & Service Representatives:

Sales Area	Sumitomo Sales and Service Representatives	
North America, CALA	SEL	Sumitomo Electric Lightwave Corp.
Europe, Middle east, Africa	SEEL	Sumitomo Electric Europe Ltd.
China	SEA	Sumitomo Electric Asia, Ltd.
	SEAC	Sumiden Asia(Shenzhen) Co., Ltd.
Thai, Vietnam	SET	Sumitomo Electric(Thailand) Limited
Indonesia, Singapore, Malaysia	SEAP	Sumitomo Electric Asia Pacific Pte. Ltd.
India, South Asia	SETI	SEI Trading India Pvt. Ltd.
Philippines	SEPI	SEI (Philippines) Incorporated
Japan	SEI	Sumitomo Electric Industries ,Ltd.

Other sales area and authorized sales and service agencies may be provided according to the country, area and trading conditions. Refer to the information which appears on the splicer screen.

IMPORTANT: PATENT NOTICE

This product and/or the use of this product are/is covered by one or more of the following Patents of Sumitomo Electric Industries, LTD.:

Australia	Patent No(s):	2002222577; 2006235914
Canada	Patent No(s):	2431138; 2560225; 2592772; 2804689; 2814387; 2823147
	Design No(s):	133128; 159489
China P. Rep.	Patent No(s):	ZL01820115.6; ZL200680000303.7; ZL200680001870.4; ZL200780001246.9; ZL201180015974.1; ZL201180060718.4; ZL201180062470.5; ZL201280037194.1; ZL201480074365.7; ZL201480074376.5;
	Design No(s):	ZL201530022425.8; ZL201730296187.9
Europe	Design No(s):	000712583-0001; 001183206-0001 001244487-0001; 002576843-0001; 004073930-0001;
France	Patent No(s):	1355177; 1892547; 1944631; 2241914; 2657736; 2660633; 2738583
Germany	Patent No(s):	1355177; 1892547; 1944631; 2241914; 2657736; 2660633; 2738583
Italy	Patent No(s):	1355177; 1892547; 2241914; 2657736; 2660633; 2738583
Sweden	Patent No(s):	1355177; 1892547
United Kingdom	Patent No(s):	1355177; 1892547; 1944631; 2241914; 2420633; 2657736; 2657737; 2660633; 2738583
Hong Kong S.A.R.	Patent No(s):	1106961
	Design No(s):	1002050.9
India	Patent No(s):	232249; 289925
	Design No(s):	209372; 225957; 232675; 267768
Japan	Patent No(s):	3952822; 4032960; 4161984; 4165375; 4196972; 4305468; 4367597; 4457873; 4613796; 5272180; 5309403; 5470661; 5810463; 6318435; 6320766; 6442802
	Design No(s):	1311936; 1382022; 1412402; 1520918; 1582501
Malaysia	Design No(s):	MY07-00454-0101; MY09-01316-0101; MY10-01443-0101
Singapore	Design No(s):	D2007/402/A; D2009/1085/Z; D2010/1065/I
South Korea	Patent No(s):	10-0646124; 10-0859070; 10-0878095; 10-1204153; 10-1211873; 10-1586964; 10-1662319; 10-1808368; 10-1819784;
	Design No(s):	30-0472617; 30-0594853; 30-0646191; 30-0831402; 30-0965529
Taiwan	Patent No(s):	233507; I412807; I435128
	Design No(s):	D140150
United States	Patent No(s):	6966708; 7140786; 7212718; 7412146; 7546020; 8254743; 8992101; 8950955; 9146354; 9488781; 10048442; 10101534
	Design No(s):	D578072; D628462; D652212; D792493; D837273

IMPORTANT : TYPE-Q102-CA+ SOFTWARE USER LICENSE

Copyright © 2020 SUMITOMO ELECTRIC INDUSTRIES, LTD. All rights reserved.

ATTENTION : The software installed in the TYPE-Q102-CA+ SPLICER (“this software”) is the property of SUMITOMO ELECTRIC INDUSTRIES, LTD. The usage of this software is granted by a license. CAREFULLY READ AND THIS LICENSE BEFORE USING THIS PRODUCT.

The copyright and all other rights to this software, its documentation and the writings concerning this software (“the writings”), which contain CD-ROM, operation manual, guiding document, data tables, command lists, writing information (photos, images, drawing, text) on appended other printed materials, shall remain with SUMITOMO ELECTRIC INDUSTRIES, LTD. By commencing the use of this software, you acknowledge that you have read the following license and indicate that you agree to its terms. In case of disagreement, contact SUMITOMO ELECTRIC INDUSTRIES, LTD. or our product supplier.

LICENSE AGREEMENT

This license is the entire agreement between SUMITOMO ELECTRIC INDUSTRIES, LTD. and you.

1. LICENSE

The following restricted rights are granted. YOU MAY :

- a) use on a splicer in which this software is installed.
- b) create or distribute a construction manual based on the writings on condition that you clarify their source.
- c) create an execution report of construction based on displayed information, and the writings.
- d) create a document (manual or execution report) concerning the maintenance of the splicer in which this software is installed or control its splice-quality upon displayed information and the writings.
- e) make one copy of the writings for archival or backup purpose.

2. RESTRICTIONS

The following act is forbidden on this license, except our prior written consent. YOU MAY NOT :

- a) sell, distribute, rent, lease, transfer, or disclose the whole or part of the writings to the public or unidentified parties and transfer, disclose or display the electrical format of the writings through online media.
- b) make copy of the writings except as permitted in this license.
- c) reverse engineer, decompile, disassemble this software and analyze, modify or merge the program.

3. CONTRACTING PARTIES

If you rent, lease, transfer, or resell the splicer, in which this software is installed, to a corporation or other entity, then this agreement is formed by and between SUMITOMO ELECTRIC INDUSTRIES, LTD. and such entity. You shall be liable for such entity to agree to the same all conditions of this license.

4. TERM AND TERMINATION

This agreement shall continue in effect until terminated. You may terminate the agreement at any time by stopping the use of the splicer in which this software is installed. If you fail to comply with any of the provision of this license, your license will be automatically terminated. Upon termination, you shall transfer the writings to the owner of splicer (In the case that you transfer the splicer to other corporation or entity) or return them to us, otherwise erase or destroy them by appropriate means. You shall forever hold in confidence all trade secrets brought by this license. Further you agree not to disclose to any third party.

5. LIMITATION OF LIABILITY

SUMITOMO ELECTRIC INDUSTRIES, LTD. and our supplier shall not be liable for consequential, incidental or accidental damages in connection with this software or this agreement and whether this software shall meet your special requirements, special efforts or special method beyond the range described in the operation manual concerning this software.

6. GENERAL

If any provision of this agreement is declared by the court of competent jurisdiction to be invalid, illegal, or unenforceable, such provision shall be severed from the agreement and the other provisions shall remain in full force and effect.

SD logo is a trademark or registered trademark of SD-3C LLC.



Apple is a trademark or registered trademark of Apple Inc.

Google play is a trademark or registered trademark of GOOGLE LLC.

Table of contents

IMPORTANT SAFETY PRECAUTIONS
IMPORTANT: REGION LIMITATION
IMPORTANT: PATENT NOTICE
IMPORTANT: TYPE-Q102-CA+ SOFTWARE USER LICENSE

1. Introduction	1-1
I Product overview	1-1
● Optical fiber requirement	1-1
● Features overview	1-2
● Standard package	1-3
I Related products	1-4
I Structure	1-5
I Screens and icons	1-11
● Home screen	1-11
● Settings panel	1-12
2. Basic splicing operation	2-1
I Preparation for splicing	2-1
I Splicer operating procedures	2-2
I Preparing power supply	2-3
● AC operation	2-3
● Battery operation	2-4
● DC operation(car battery)	2-7
I Optical fiber splicing	2-8
● Turning on/off the splicer	2-8
● Selecting splice program	2-9
● Selecting heater program	2-10
● Stripping the fiber coating / Cleaning the bare fiber	2-11
● Cleaving the fiber	2-12
● Inserting fibers into the splicer	2-14
● Arc test	2-15
● Starting the automatic splice	2-17
● Proof test	2-20
● Splice protection	2-21
I Drop cable splicing	2-23
● Applicable cable	2-23
● Required items	2-23
● Preparation	2-23
● Removing cable sheath	2-24
● Fiber preparation procedures 1 (AP-FC6SA is available)	2-25
● Fiber preparation procedures 2 (AP-FC6SA is not available)	2-26
● Inserting the fiber into the splicer	2-27
● Splice protection	2-28
3. Maintenance	3-1
I Cleaning	3-1
● Cleaning V-grooves	3-1
● Cleaning LEDs and bare fiber pads	3-2
● Cleaning lens protection glass	3-3
● Cleaning heat shrink oven	3-4
I Electrode replacement	3-5
● Electrode replacement procedures	3-6
I Packing and storage instructions	3-8
I Software update via internet	3-9

Table of contents

4. Splice program	4-1
Splice program list	4-1
Customizing splice program	4-3
Copying splice program(in Administrator mode)	4-4
Showing /Hiding splice program (in Administrator mode)	4-5
Splice program editable items	4-6
NanoTune™ splice mode	4-9
Attenuation splice mode	4-10
5. Heater program	5-1
Heater program list	5-1
Customizing heater program	5-3
Copying heater program(in Administrator mode)	5-4
Showing /Hiding heater program (in Administrator mode)	5-5
Heater program editable items	5-6
6. Functions	6-1
Menu screen	6-1
Operation Settings	6-2
Function Settings	6-5
Splice Data	6-7
Maintenance	6-9
SumiCloud™	6-10
Information	6-12
7. Other convenient functions	7-1
Back monitor type	7-1
Universal clamp	7-2
Fiber holder operation	7-3
Detachable /attachable bare fiber pads	7-4
Heater clamp operation	7-5
Auto start	7-6
Tripod fixing screws	7-6
Hand strap	7-7
8. Administrator mode	8-1
Logging in to and logging out of Administrator mode	8-1
Changing Administrator password	8-2
Lock functions	8-3
● Startup password protection	8-3
● Locking the settings (all)	8-5
● Locking the settings (individual)	8-6
9. Troubleshooting	9-1
● Arc problems	9-1
● Fiber breakage	9-1
● Splicer is not turned on	9-1
Error message list	9-2
Warranty and repair service	9-7

■ Sumitomo Electric industries, Ltd. reserves the right to change the specification or design without notice and may therefore not coincide with the contents of the manual.
E&OE

Product overview

The TYPE-Q102-CA+ automatically pre-inspects and aligns a pair of optical single fibers with equipped microscopes, and then fuses them together with heat from an electric arc to form a low-loss splice. A protection sleeve is applied over the bare glass and cured in the built-in heat shrink oven.



Optical fiber requirement

The TYPE-Q102-CA+ can splice the following optical fiber types.

Material	Silica glass
Profile types	SMF (ITU-T G.652), MMF (ITU-T G.651), DSF (ITU-T G.653), NZDSF (ITU-T G.655, G.656), BIF (ITU-T G.657), CSF (ITU-T G.654), EDF
Fiber diameter	80 - 150 μ m ^{*1}
Fiber coating diameter	100 - 1,000 μ m
Fiber count	Single fiber
Cleave length ^{*2}	5 - 16mm ^{*3}

*1 Fiber diameter except 125 μ m are only applied in room temperature and 0m altitude.

*2 The applicable fiber protection sleeves vary depending on the cleave length.

*3 Over 250 μ m coating diameter with the length less than 8mm require fiber holder operation.









Read this manual carefully in its entirety to fully understand machine capabilities. Save this manual in a location in which you can easily get to see.

1. Introduction

● Features overview

The TYPE-Q102-CA+ key features are:

	<p>NanoTune™ Technology</p> <p>The NanoTune™ analyzes a fiber end face and automatically fine-tunes splice condition to achieve an ideal splice. Coping with poorly cleaved optical fiber, which cannot be spliced by conventional splicers, the NanoTune™ can yield the best quality and low loss splices.</p> <p>▶P.4-9 NanoTune splice mode</p>
	<p>Wireless LAN connectivity and "SumiCloud™"</p> <p>Using the dedicated wireless LAN SD card, you can connect the splicer to your smartphone and enjoy the SumiCloud™ services like; Splice Data Management, Report Builder, Help video, Software update, etc.</p> <p>▶P.6-10 SumiCloud™</p>
	<p>Preventive maintenance</p> <p>When there is a sign of deterioration on a fusion splicer or an accessory such as a cleaver, the SumiCloud™ notifies a user as a caution or warning message. The caution or warning message is sent to a field installer's smartphone, and at the same time emailed to an administrator.</p> <p>▶P.6-11 SumiCloud™ function</p>
	<p>High speed dual independent ovens</p> <p>The TYPE-Q102-CA+ incorporates high speed dual independent heat shrink ovens and achieves perfectly consecutive splices with no waiting time. The dual ovens contribute to improvement of splicing efficiency, yielding high productivity.</p>
	<p>Proven field toughness</p> <p>The TYPE-Q102-CA+ is equipped with shock proof bumper that protects it against shock from dropping. With drip proof and dust proof equivalent to IP52, the splicer offers stable performance even in harsh environments.</p>
	<p>Long life battery</p> <p>The TYPE-Q102-CA+ has ECO-mode (power saving function) to reduce battery consumption.</p> <p>High capacity battery enables approx. 320 splice and heat cycles per charge.</p>

1. Introduction

Standard package

Here is an example of TYPE-Q102-CA+ standard pack-

Package contents (example)

No.	Description	Part number	Quantity
1	Fusion splicer	TYPE-Q102-CA+	1 pc
2	Carrying case	CC-72	1 pc
3	Battery pack	BU-16	1 pc
4	AC adapter	ADC-16	1 pc
5	Power cord	PC-AC<X>* ¹	1 pc
6	Spare electrodes	ER-10	1 pair (2 pcs)
7	USB cable	—	1 pc
8	Cooling tray	—	1 pc
9	Hand strap	—	1 pc
10	Quick reference guide * ²	OME2024009-2	1 pc

*1: X=2(USA), X=10(BRAZIL)

*2: The latest version is provided.

The above package is an example. The package contents vary depending on the customers' requests.

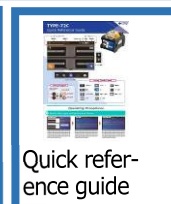
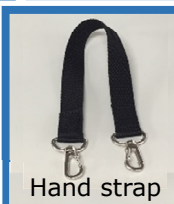
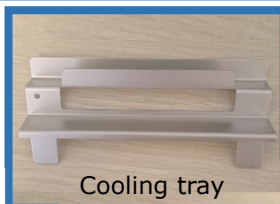

1. Introduction

Related products

To place an order for tools, consumables, and optional accessories, please contact our sales personnel.

Optional accessories

Part name	Part No.	Description
<Optional accessories for main unit>		
Battery pack	BU-16	Li-ion battery for TYPE-Q102-CA+
Car battery cable	PCV-16	Plugged into a car's cigarette light jack to supply power to splicer
AC adapter	ADC-16	AC adapter for TYPE-Q102-CA+
Battery charger	BC-16	Use only for the battery pack BU-16
Wireless LAN SD card	WLS-0416	Dedicated Wireless LAN SD card for the TYPE-Q102-CA+
Fiber holders	FHS-025	For 0.25mm coated fiber
	FHS-09	For 0.9mm coated fiber
	FHS-05	For 0.5mm coated fiber
	FHD-1	For drop and indoor cable
Transfer tool	TRT-11	Transfer tool for drop and small-sized indoor cables. Prevents the cable twisting when
Dispenser	HR-3	Dispenser for alcohol
<Tools>		
Fiber cleaver	FC-8R-FC	Applicable coating diameter: 250 - 900µm Applicable fiber diameter: 125µm Replacement blade for FC-6R and FC-8R: FCP-20BL(7R) Replacement blade for FC-6:FCP-20BL
	FC-8R-F	
	FC-6S(-C)	
	FC-6RS(-C)	
	FC-6S-5C	
Jacket remover	JR-M03	Jacket remover for single fiber
	JR-25	Jacket remover for single fiber
	JR-26-D	Multi remover for drop cable splicing

Consumables

Fiber protection sleeves, electrodes and battery pack are consumables. To place an order, please contact our sales personnel.

Part name	Part No.	Description	Quantity
Fiber protection sleeves	FPS-1	For single fiber ϕ 0.25mm~0.9mm Length 60mm, Cleave length \leq 16mm	50 pcs/pack
	FPS-40	For single fiber ϕ 0.25mm~0.9mm Length 40mm, Cleave length \leq 10mm	50 pcs/pack
	FPS-61-2.6	For single fiber ϕ 0.25mm~0.9mm Length 61mm, Cleave length \leq 16mm	100pcs/pack
Fiber protection sleeve for cable sheath	FPS-D60	For drop cable, small-sized indoor cable Length 60mm, Cleave length \leq 10mm	25 pcs/pack
Electrodes	ER-10	These parts degrade with time and usage and cannot be recycled. New parts as a replacement should be purchased.	1 pair
Battery pack	BU-16		1 pc

Structure

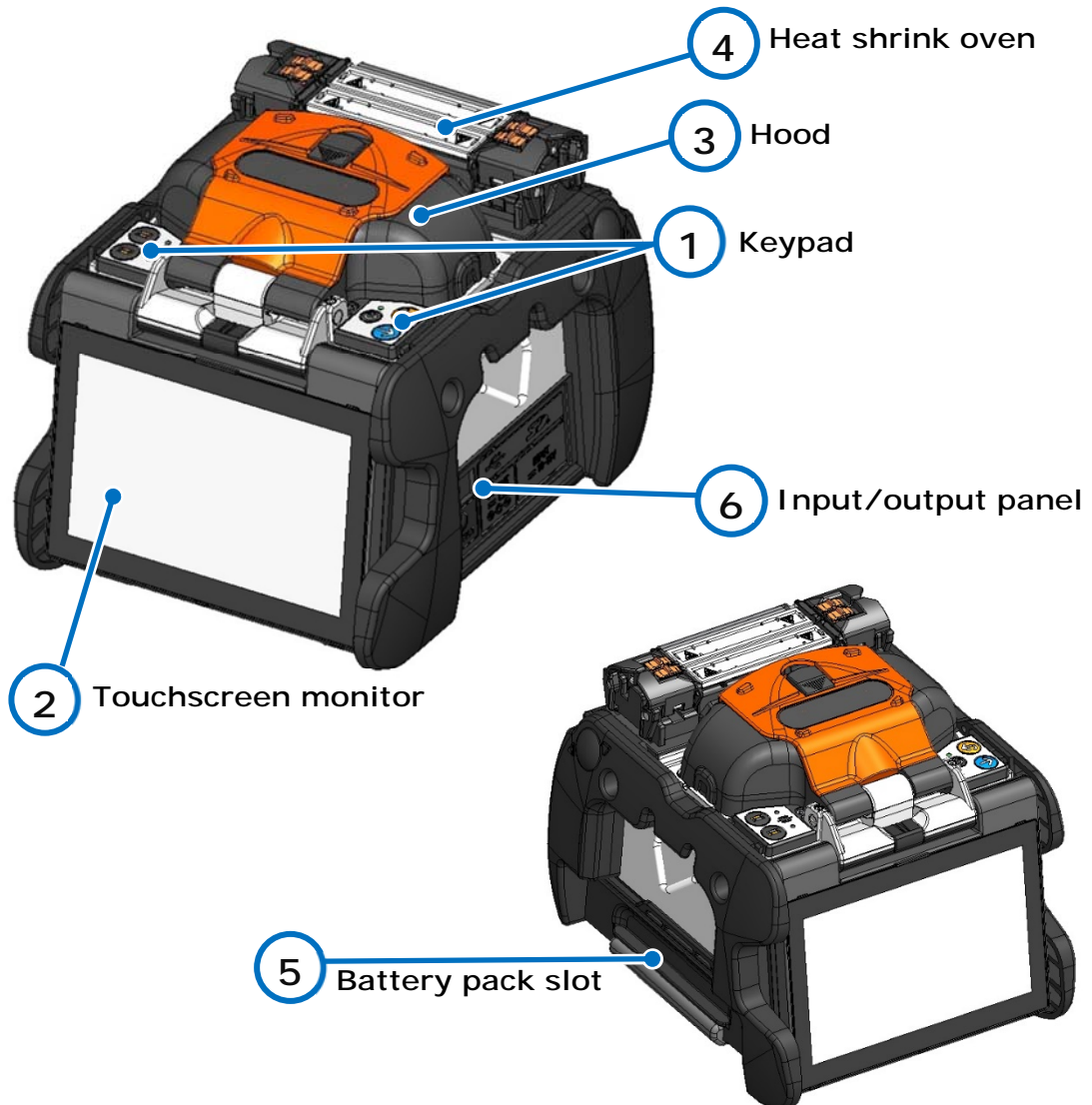

1 Keypad

Keys are used to turn on/off the power, perform a splice and heat shrink protection, and set up functions.

2 Touchscreen monitor

Displays fiber image, splice data and menu. Touchscreen enables to start the splicing and heating processes and edit the settings.

3 Hood

Provides protection from various Environmental conditions.

4 Heat shrink oven

Used to heat and shrink fiber protection sleeves. The splicer has 2 independent heat shrink ovens (front and rear).

5 Battery pack slot

Battery is installed in the slot and protective by the lid of the slot.

6 Input/output panel

DC output terminal for hot jacket remover and USB port.

1. Introduction

■ Keypad

Keys are equipped on the top of the splicer. There are also SET, RESET and HEAT icons on the touchscreen monitor.

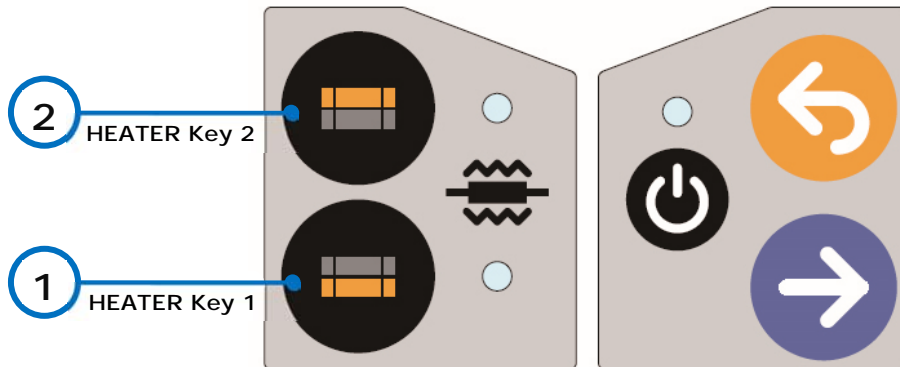

2 HEATER key2/ LED
Starts/cancels the heating cycle of the rear heat shrink oven.



1 HEATER key1/ LED
Starts/cancels the heating cycle of the front heat shrink oven.
The LED illuminates during the heat cycle.
It blinks during the pre-heating processes.



POWER key
Turns on and off the splicer. LED illuminates while the splicer is on.



RESET key
Cancels the splicing process. Initialization



SET key
Starts the splicing process.

■ Heat shrink oven

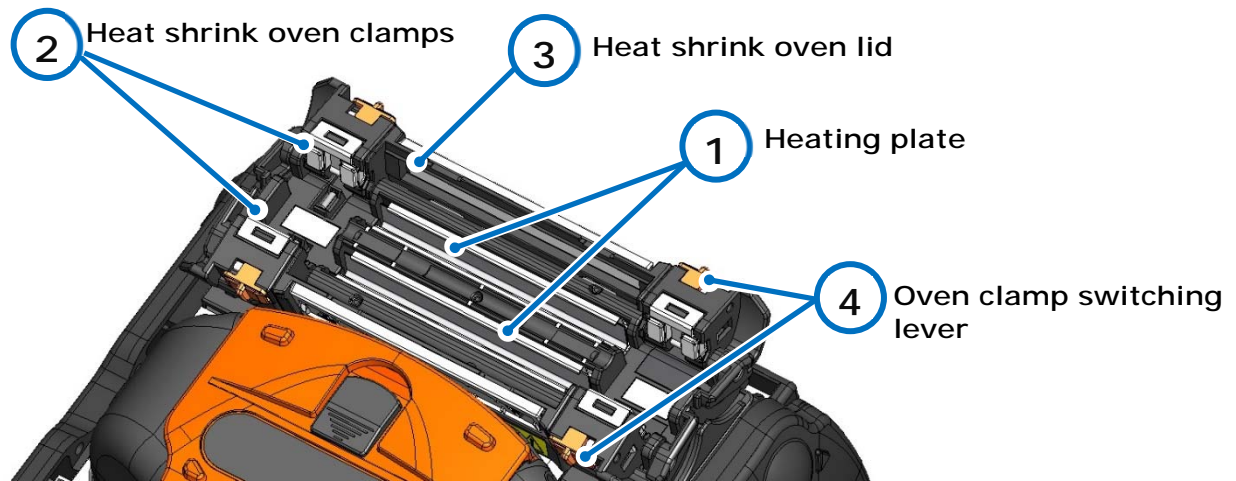

1

Heating plate
Heats fiber protection sleeve.

3

Heat shrink oven lid

2

Heat shrink oven clamps
Hold fibers straight.

4

Oven clamp switching lever
Link the lid with the clamps or separate the lid from the clamps.
▶P.7-5: Heater clamp operation

1. Introduction

■ V-grooves, electrodes, other components

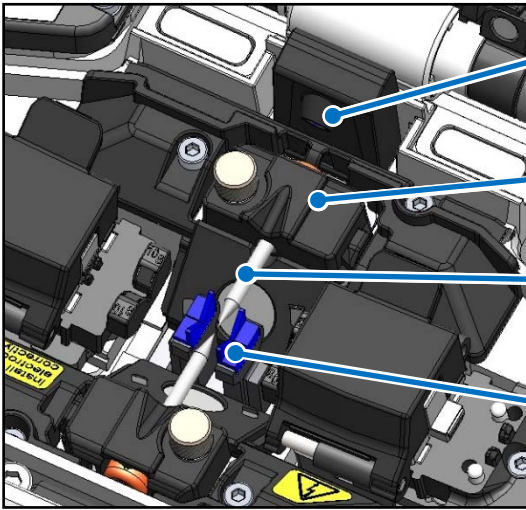

- 1 V-groove illumination**
Illuminates the V-groove. Lit when the hood is opened.
- 2 Electrode cover plate**
Holds the electrode seated into the retaining groove.
- 3 Electrodes**
Arc is generated between the electrodes.
- 4 V-grooves**
Keep bare fibers aligned.

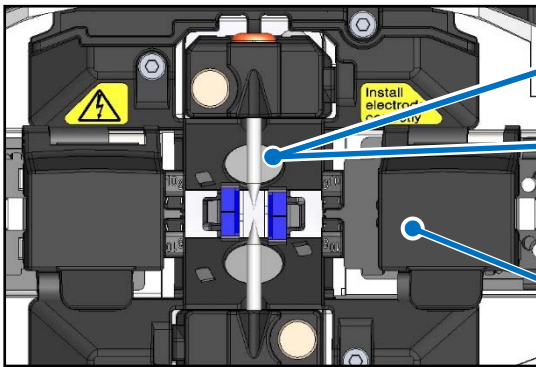

- 5 Lens protection glass**
Protects the lens surface.
- 6 Microscope objective lens**
Fiber is observed through the lens.
- 7 Fiber coating clamp**
Holds fiber coating.

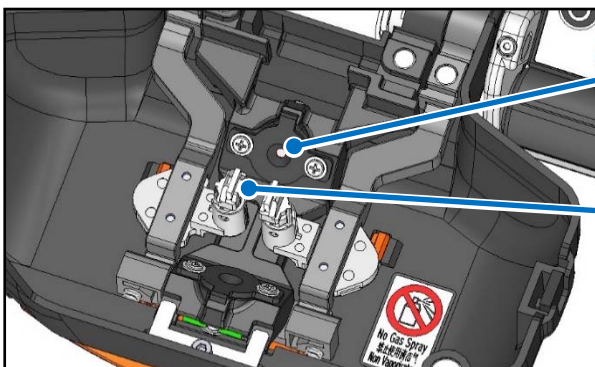

- 8 LED for fiber observation**
Illuminates the fiber and make an image on the microscope.
- 9 Bare fiber pads**
Hold fibers seated into the V-grooves. Normally they are attached to the hood.

■ Input/output panel

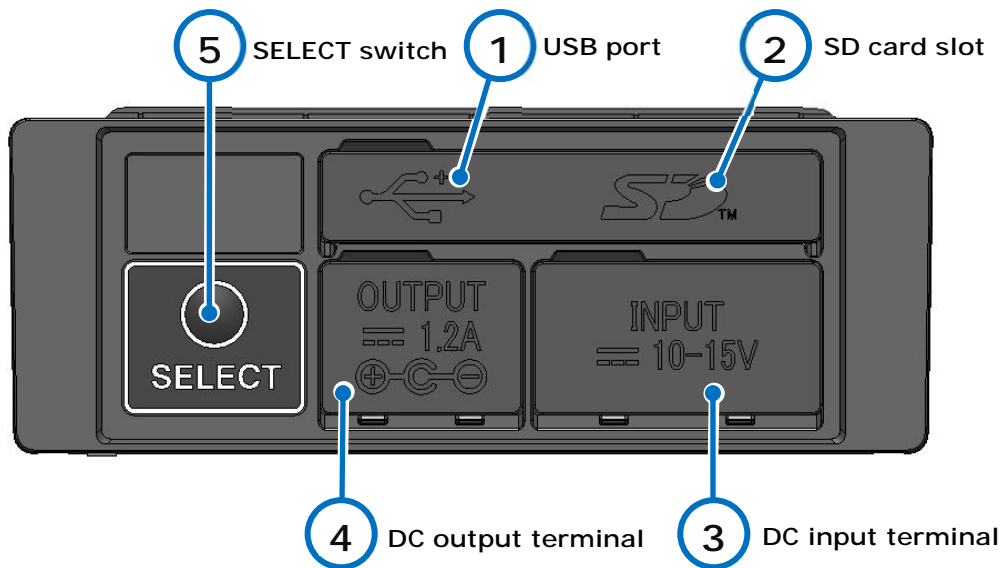

- 1** **USB port**
Used to download stored splice loss data when connected to a PC.
- 2** **SD card slot**
For splice data output. Insert Wireless LAN SD card in this slot when using SumiCloud™.
- 3** **DC input terminal**
Input power via AC adapter.
- 4** **DC output terminal**
Used to supply DC power to a hot jacket remover.
- 5** **SELECT switch**
Displays Splice/Heater program selection screen. (▶See below)



Caution

- To ensure drip-proof and dust-proof performances, close input/output panel securely.
- Do not press the keys on the keypad with a sharp object (e.g. a ballpoint pen, screwdriver, or nail) Doing so will damage the keypad.

SELECT switch feature

The SELECT switch helps you select splice and heater programs when the touchscreen does not work. Follow the procedures below.

- 1) Turn the power OFF. (if the splicer is powered on.)
- 2-A) If you have not set a start-up password, turn the power ON while keep holding down the SELECT switch until "Splice Program" screen is displayed. (Refer to Page 2-9 of Guide to Operation.)
Go to step 3).
- 2-B) If you've set a start-up password, turn the power ON while keep holding down the SELECT switch until a start-up password entry screen is displayed. Enter your start-up password referring to the instruction below.

HEATER key 1: Moves the cursor to left*

RESET key: Moves the cursor to right*

POWER key: Moves the cursor down*

SET key: Enters the number/letter

*Holding down the key marked * when the cursor is at the end will cause the cursor to jump to the other end.*

Once the start-up password matches, the splicer will show "Splice Program" screen. Proceed to step 3).

- 3) Select splice program with HEATER keys, and then determine with SET key.
- 4) "Heater program" screen is displayed. (Refer to Page 2-10 of Guide to Operation.) Select heater program with HEAT keys, and then determine with SET key.

We recommend you contact our authorized service center promptly if the touchscreen does not work.

1. Introduction

■ Caution label

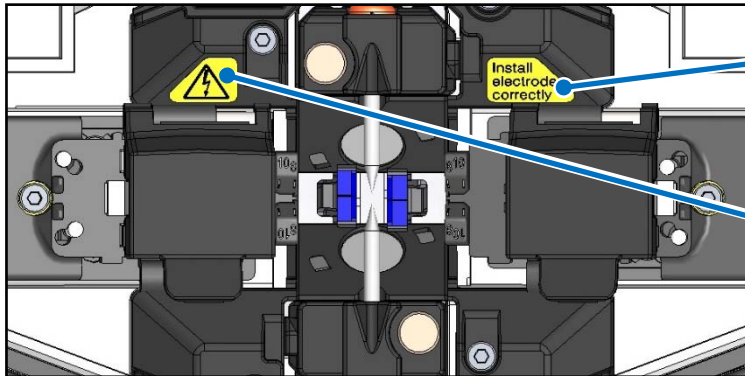

1 Installing electrode

2 High voltage

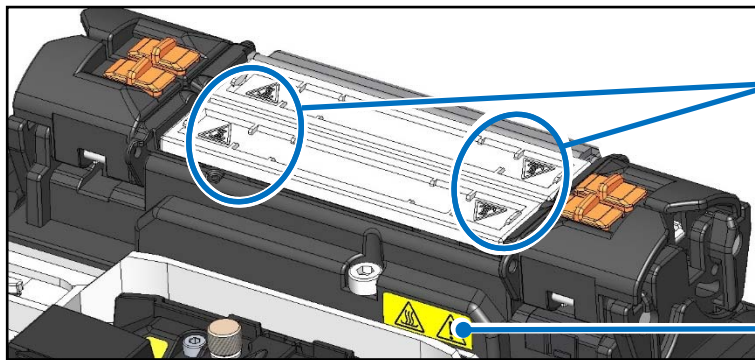

3 High temperature heater

4 High temperature heater

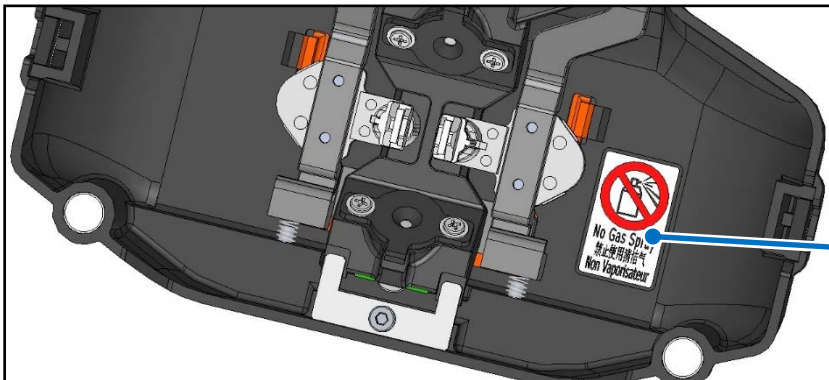

5 Prohibition of using spray

1 **Installing electrode**
Before splicing make sure the electrode is installed in the splicer properly.

2 **High voltage**
High voltage is generated in the electrode during an arc. Unplug the power cord and remove the battery pack before you access the electrode.

3 **High temperature heater**
The Heater reaches approx. 200°C. Take care when you run the heater.

5 **Prohibition of using spray**
Do not use any gas spray such as gas duster or canned air.

Screens and icons

Home screen

After the splicer is turned on, Home screen is displayed.

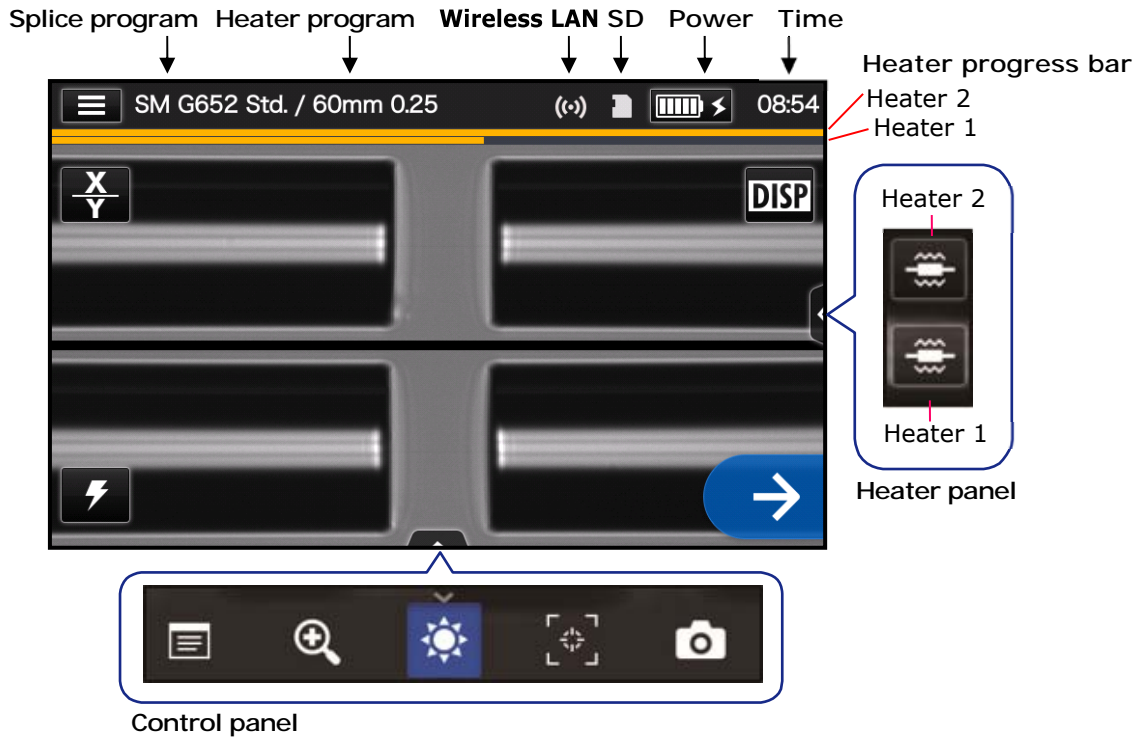

	Settings panel icon: Display the Settings panel.
	Power source type: Shows AC power or battery power. For battery use, the battery icon shows the battery level. When the battery icon is tapped, estimated splice cycles per remaining capacity is displayed.
	Change image view: Shows the currently selected image view type. When the icon is tapped, the image view type is changed to (dual, tandem) ⇒ (dual, side by side) ⇒ (single) ⇒ (single) ⇒ (single) .
	Show/hide icons at the top of the screen.
	Start the splicing process.





Heater panel			Start the heating process on heater 1 and 2
Control panel			View splice data after splicing.
			Adjust the zoom of a fiber image viewed on the screen. (Available when or is selected)
			Adjust display brightness.
			Adjust the focus of a fiber image viewed on the screen. (Available when or is selected)
			Capture a fiber image on the screen.

1. Introduction

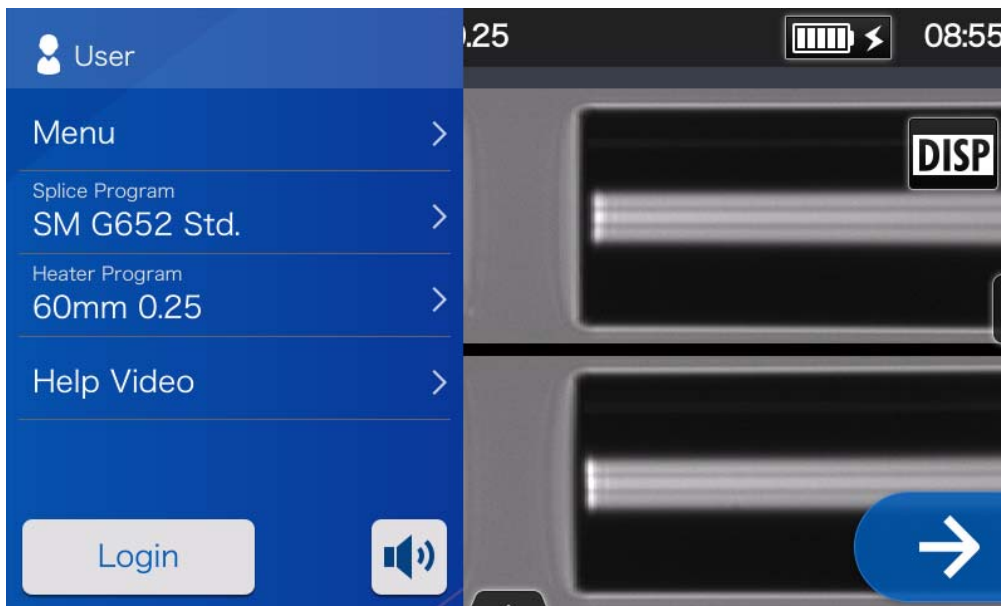
● Settings panel

To display the Settings panel, tap the Settings panel icon on the Home screen.

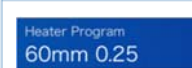

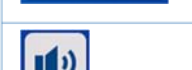
	Display the Menu screen. You can edit settings. ▶For more details, see Chapter 6
	Set up splice program. ▶P.2-9: Selecting splice program, Chapter 4: Splice program
	Set up heater program. ▶P.2-10: Selecting heater program, Chapter 5: Heater program
	Play a help video to learn fiber preparation etc.
	Log in to Administrator mode by entering a password. You can use some more useful Administrator functions. ▶Chapter 8: Administrator mode
	Adjust the volume

Special note on monitors

Although bright spots or dark spots may appear on the screen, this is a unique characteristic of liquid crystal displays, and such do not constitute or imply a machine defect.

2. Basic splicing operation

This chapter describes basic fiber splicing operation using fusion splicer.

Preparation for splicing

Before splicing, get all the necessary items ready.

TYPE-Q102-CA+ standard package

- Jacket remover
- Fiber cleaver
- Fiber protection sleeves*
- Pure (more than 99%) alcohol
- Lint-free gauze wipes

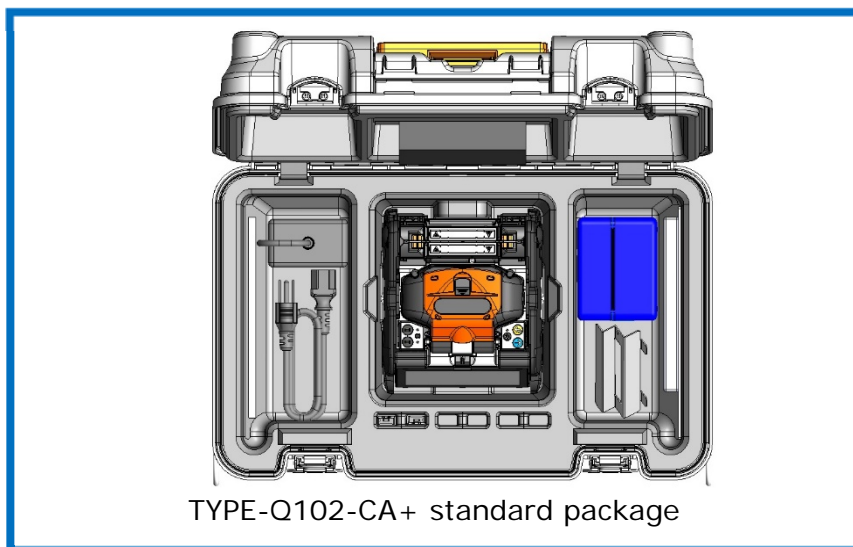

*Note that the applicable fiber protection sleeves differ depending on the cleave length. ▶P.5-2

2. Basic splicing operation

Splicer operating procedures

The following is a summary of the steps required to make a splice with the fusion splicer. For further information on each step, please see the page described below.

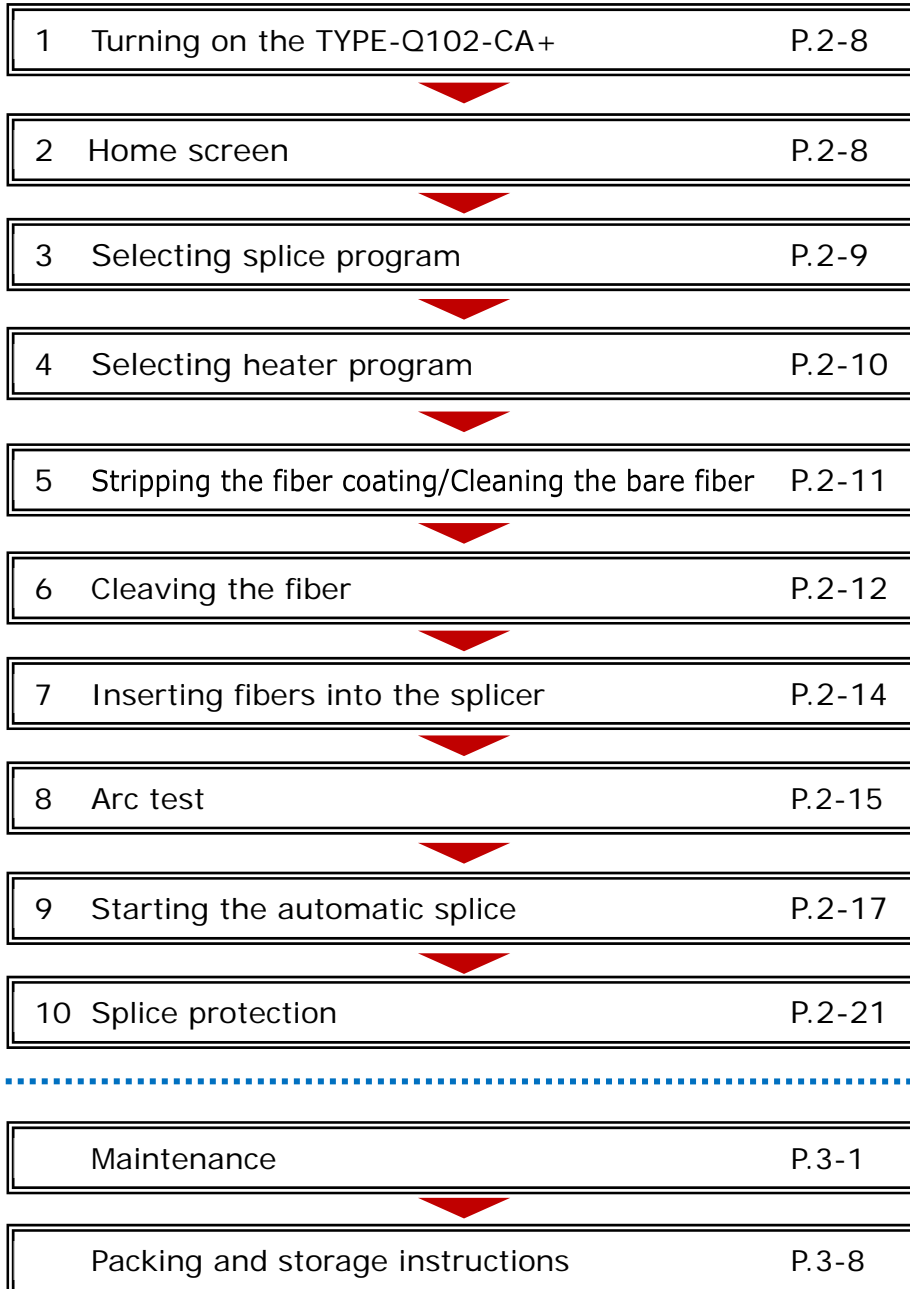

2. Basic splicing operation

Preparing power supply

The TYPE-Q102-CA+ is powered from AC adapter or battery.

AC operation

Connect the AC adapter (ADC-16) to the TYPE-Q102-CA+ when you operate the splicer on AC power.

Plugging

Insert the power cord into the AC adapter completely.

Connect the output cord of the AC adapter to the DC input terminal of the TYPE-Q102-CA+.

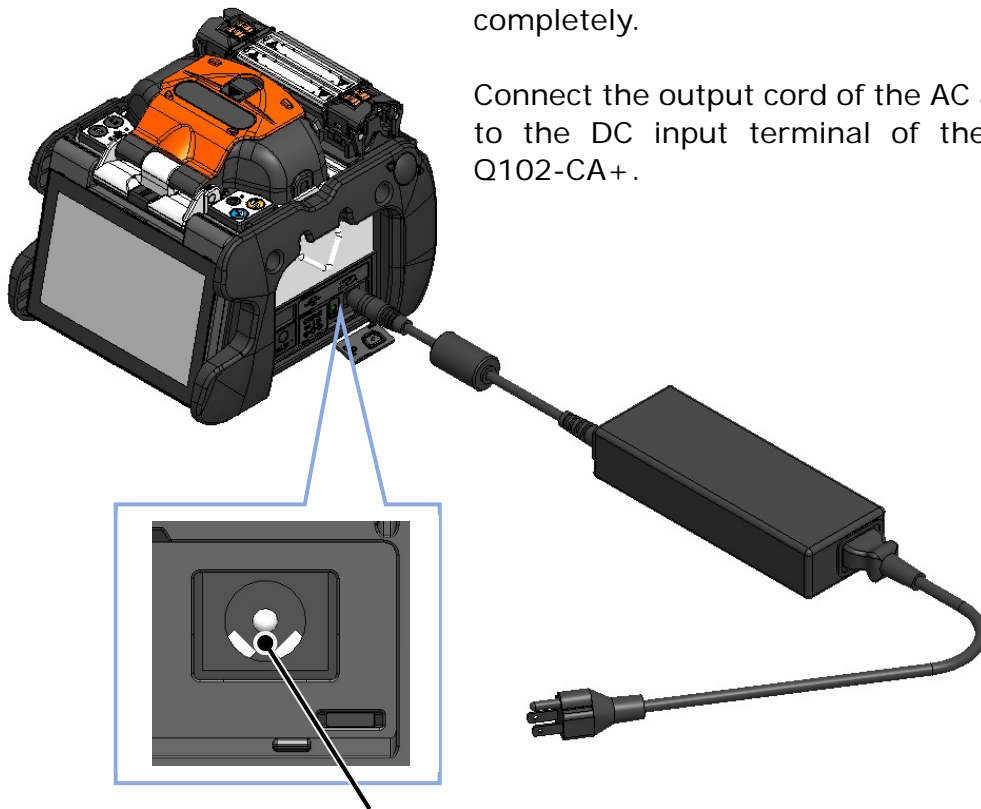

DC input terminal



Caution

1. Check the voltage of the AC power supply before use. Be sure to ground the AC adapter by using a power cord with earth terminal.
2. The safety function may activate when voltage and frequency beyond the specification are applied to the AC adapter, causing the AC adapter to stop running.
In this case, the AC adapter needs replacing for a fee.
Contact our maintenance service center.
3. Place the AC adapter in a proper location so you can unplug the power cord immediately in case of emergency.

2. Basic splicing operation

Battery operation

Install the battery pack (BU-16) into the slot of the TYPE-Q102-CA+ as described below. Turn off the splicer and disconnect the AC adapter from the splicer before installing and removing the battery pack.

- ▶P.2-5 "Battery charging"
- ▶P.2-6 "Battery level check"

Battery pack installation

Insert the battery pack straight all the way in the slot.

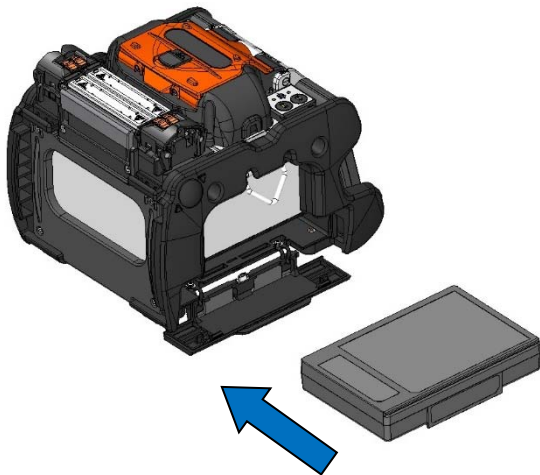

Battery pack removal

Open the cover of the slot. Hook your finger to the projection of the battery pack, and then slide it out in the direction of the arrow.

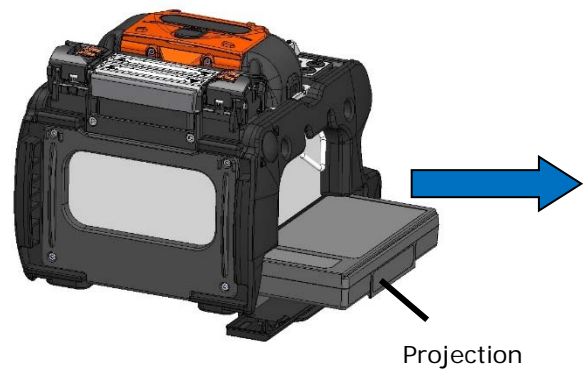

Opening and closing the cover of the battery pack slot

Open

- ① Slide the lock in the direction of the arrow to unlock the cover.
- ② Open the cover.

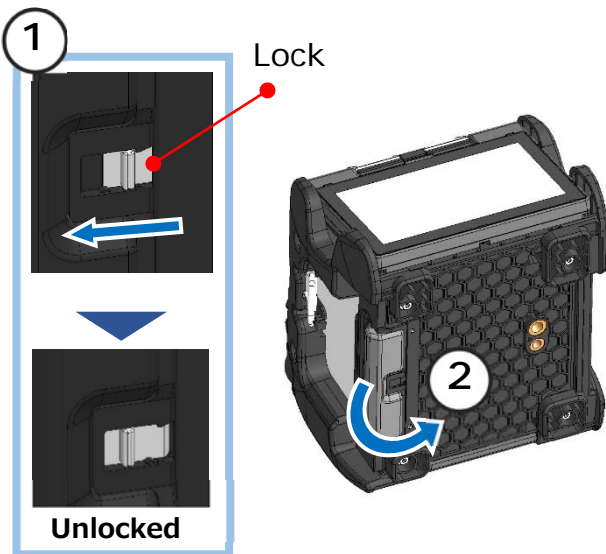

Close

- ① Insert the tab of the cover into the slot. Close the cover.
- ② Lock the cover securely.

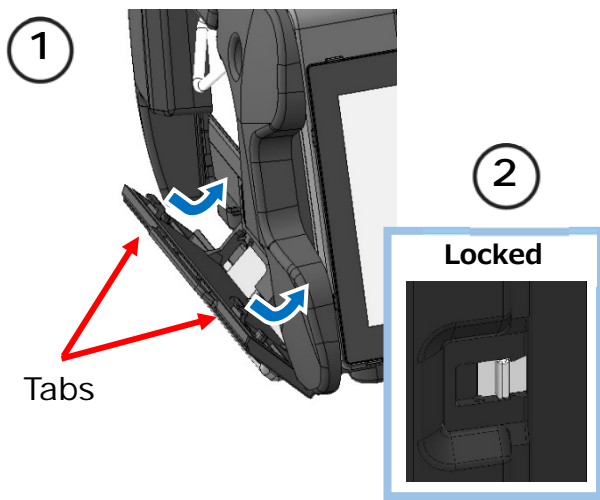

To ensure drip-proof and dust-proof performances, close the battery cover securely.

2. Basic splicing operation

■ Battery charging

- Before using the battery pack for the first time, charge the battery pack. (The battery is not fully charged before shipping.)

- 1: Insert the battery pack into the TYPE-Q102-CA+.
- 2: Connect the AC adapter to the TYPE-Q102-CA+.
- 3: The LED (green) next to the DC input terminal blinks and the charging is started.
- 4: It takes 4 hours to finish charging though the charging time differs according to the remaining battery capacity. The LED (green) illuminates when the charging completes.

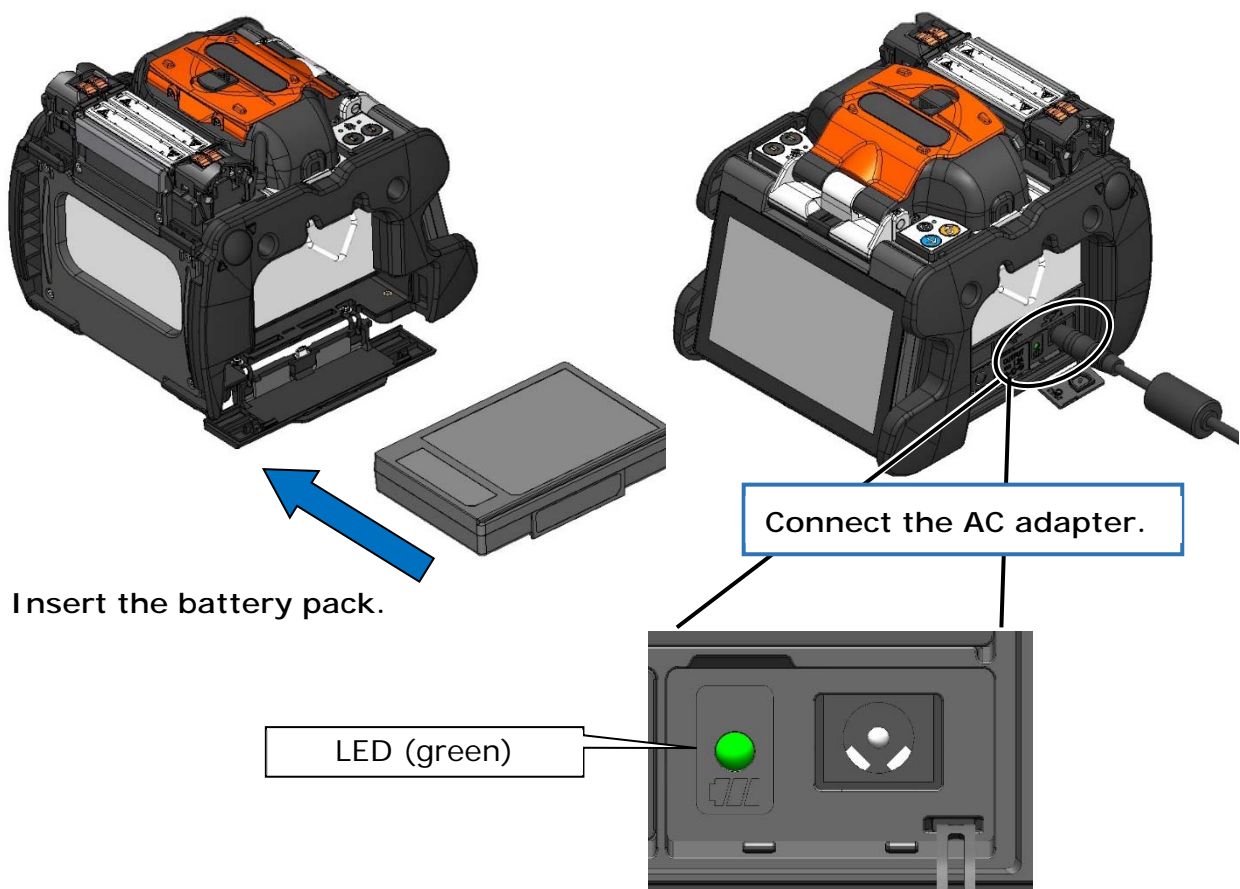

Caution

- The battery pack can be charged while the splicer is in use. However, it takes a longer compared with the time when the splicer is turned off.
- Charge the battery in the following temperature range. The battery pack might be deteriorated (decrease in capacity) at the temperature that exceeds the range.

*Temperature range for charging: 0°C ~ +40°C

2. Basic splicing operation

■ Battery level check

- Check the battery level on the battery pack

Press the battery check button. The LED will light up for a few seconds to indicate the battery status in one of five levels.

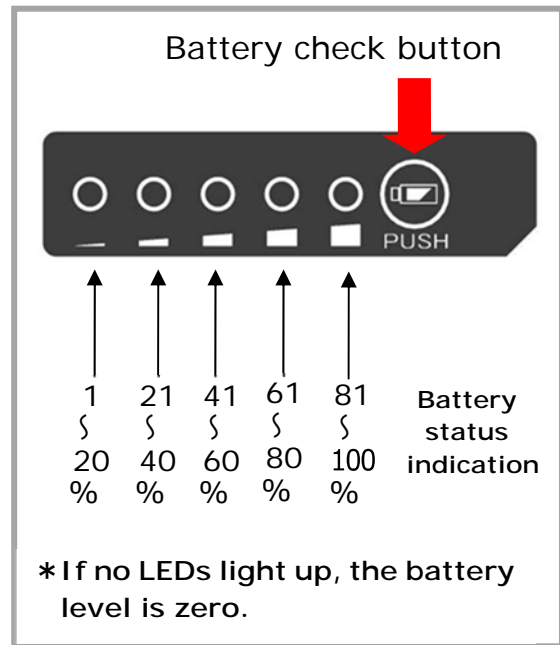
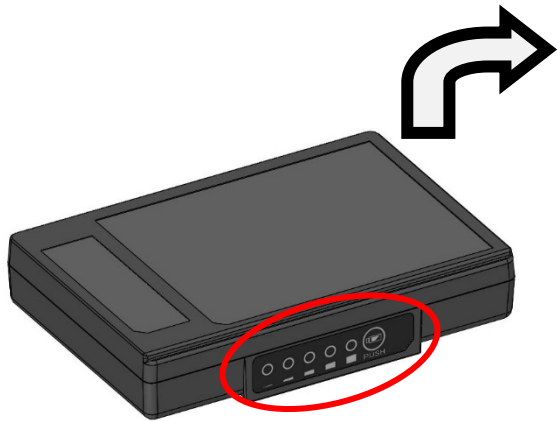

- Check the battery level on the monitor

The battery level is also displayed as a battery level indicator on the monitor. Splice and heat cycles possible with remaining battery level is indicated when you tap the indicator.

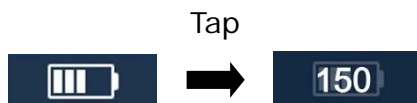

*The possible cycle displayed on the monitor is estimated based on the remaining battery level. It changes according to the operational environment and condition. (No guaranteed value)

Status	Current battery level					
	0~5%	6~20%	21~40%	41~60%	61~80%	81~100%
Discharging						
Charging						

Be sure to charge the battery before use if the battery level is low.

2. Basic splicing operation

Precautions for battery pack

- The battery pack is consumables. Repeated charging and discharging decreases battery life.
- Store the battery pack within the following temperature range. Failure to do so may lead to deterioration in performance.
 - *Battery pack storage temperature range:
 - 20°C ~ +50°C (if stored for less than 1 month)
 - 20°C ~ +40°C (if stored for less than 3 months)
 - 20°C ~ +20°C (if stored for less than 1 year)
- Do not use or store the battery pack at high temperature, such as in strong direct sunlight, in cars during hot weather. This may cause leakage of battery fluid.
- If you are not going to use the battery pack for a long period, charge the battery pack once every 6 months.
- If you are not going to use the splicer, remove the battery pack from the splicer.

When should the battery be replaced?

When the splice cycle decreases extremely with a fully charged battery, a new battery pack should be purchased.

When disposing of the battery pack, contact our maintenance service center or follow the local regulations.

- It may take approximately 30 minutes before the battery pack goes into a quick charging mode.
Please wait for a while after start charging.

● DC operation (car battery)

The car battery cable PCV-16 (option) is required to operate the splicer on DC power (car battery). Contact a sales representative.

2. Basic splicing operation

Optical fiber splicing

Turning on/off the splicer

Turning on the splicer

- 1: Ensure that the electrodes are fully inserted in the splicer.
- 2: Insert the output cord of the AC adapter into the DC input terminal.
- 3: Adjust the monitor angle to your own preference.
- 4: Press the Power key (🔌) for more than 1 second to turn on the power. Each motor of the splicer is initialized after turning on the power, and then Home screen is displayed after a few seconds.

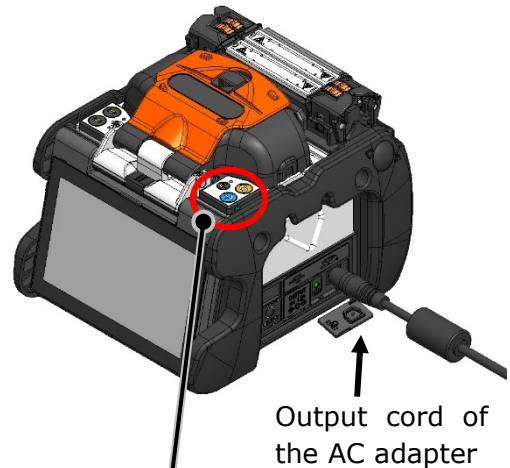

Power key



If you press the Power key right after connecting the power cord to the power supply module, it may take a few seconds until the splicer is powered on.

Home screen



After splicer is turned on, Home screen is displayed

Settings panel screen

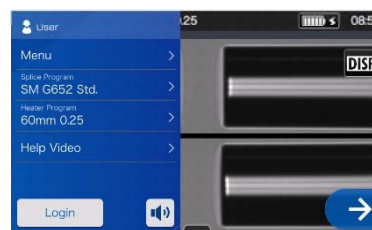

To display the Settings panel, tap the Settings panel icon (☰) on the Home screen.

►P.1-11 Screens and icons

Turning off the splicer

Press the Power key (🔌) for more than 1 second to turn off the power.

2. Basic splicing operation

● Selecting splice program



1: Tap the Splice program label on the Settings panel.

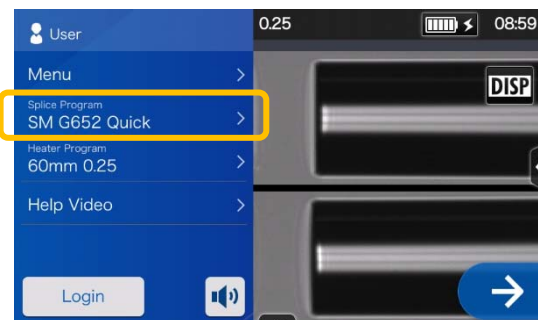

4: Splice program is changed.



Splice Program screen

2: Select a fiber category.



3: Tap the splice program you would like to use.

- ▶ P.4-1, P.4-2 Splice program list
- ▶ P.4-3 Customizing splice program

2. Basic splicing operation

● Selecting heater program

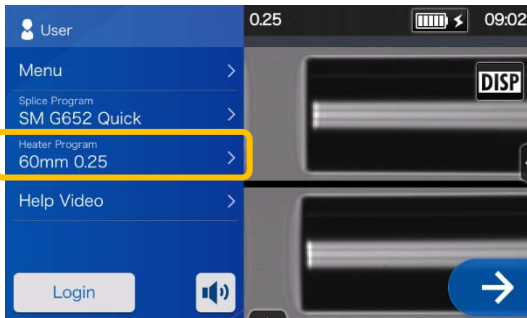

1: Tap the Heater program label on the Settings panel.

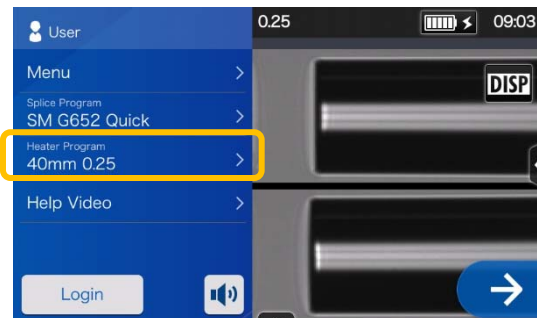

4: Heater program is changed.



Heater Program screen

2: Select a sleeve type.



3: Tap the heater program you would like to use.

- ▶ P.5-1, P.5-2 Heater program list
- ▶ P.5-3 Customizing heater program

2. Basic splicing operation

● Stripping the fiber coating / Cleaning the bare fiber

- 1: Clean the fiber coating thoroughly to remove cable gel or other stains.
- 2: Strip Approx. 30~40mm of the fiber coating with a jacket remover. (An example shows use of Sumitomo JR-M03 jacket remover and the strip length shown below applies to any stripping tools. If you use other model, please refer to its operation manual.)

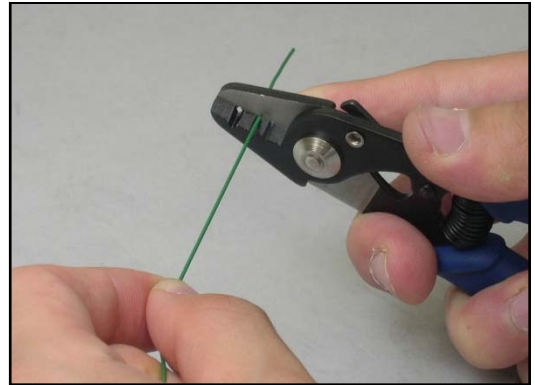

*If the stripping length is too long, the fiber cleaver cannot collect an off-cut in the off-cut collector.

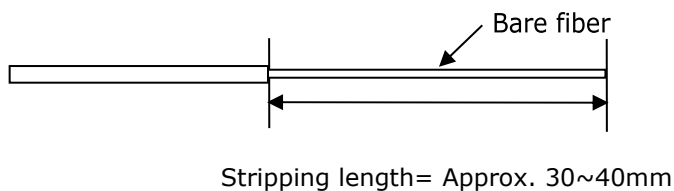

Use the correct groove of the remover according to the fiber coating diameter.
→ See figure <1>.

<1> Check the fiber coating diameter.



(1)(2)(3)

- (1) Fiber coating diameter : 1.6-3mm
- (2) Fiber coating diameter : 600-900 μ m
- (3) Fiber coating diameter : 250 μ m

The JR-M03 strips approx. 25mm of fiber coating at a time. To strip 30~40mm of the fiber coating, repeat the stripping operation.

- 3: Repeat the stripping process for the other fiber.
- 4: Clean the bare fiber from the end of the fiber coating with a lint-free gauze pad moistened with pure alcohol. Pull the bare fiber through the gauze pad. Rotate the fiber by 90 degrees to remove any coating residue. Do not reuse the gauze pad that was used.

Keep the fiber squeaky clean.

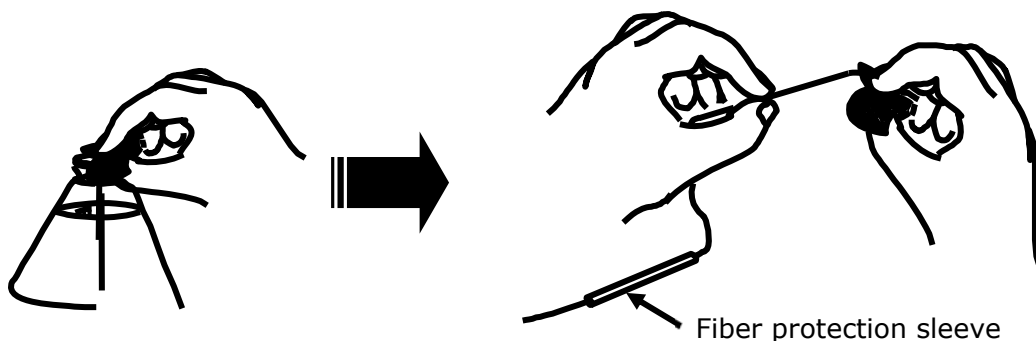

2. Basic splicing operation

● Cleaving the fiber

Cleave the fiber. (An example shows use of Sumitomo FC-6S fiber cleaver, the cleave length shown applies to any cleaving tools. If you use other model, please refer to its operation manual.)

Applicable cleave length: 5mm-20mm ($\phi 0.25\text{mm}$), 10-20mm ($\phi 0.9\text{mm}$)

*A maximum cleave length for the TYPE-Q102-CA+ is 16mm.

- 1: Open the top clamp lever and the lid of the single fiber adapter. The blade carriage should be in the forward position.

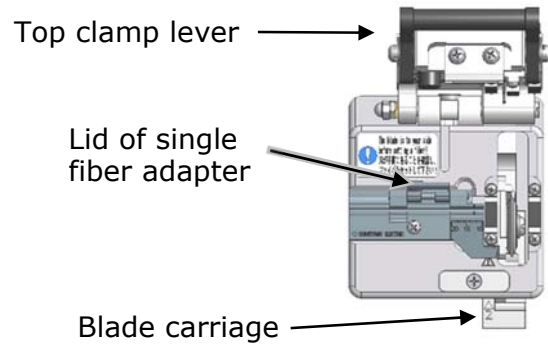

- 2: Lower the fiber straight into the correct groove of the single fiber adapter with the end of the fiber coating **at the 16mm mark on the ruler** (e.g. if the cleave length is 16mm).

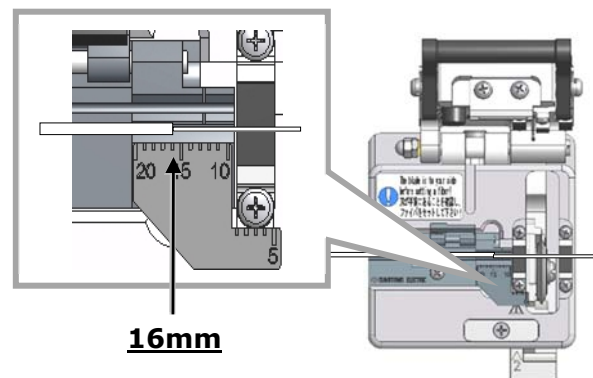

- 3: Close the lid of the single fiber adapter.

Lower the top clamp lever.

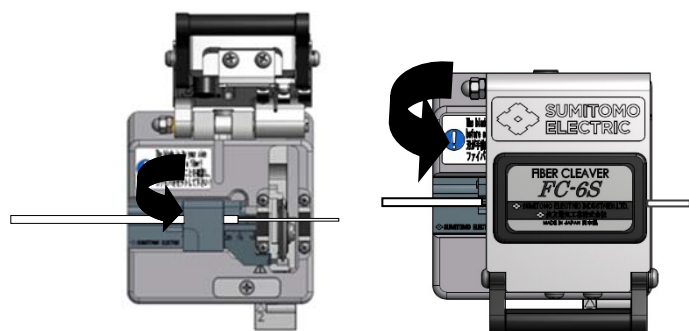

- 4: Slide the blade carriage to the rear of the cleaver as indicated by the arrow.

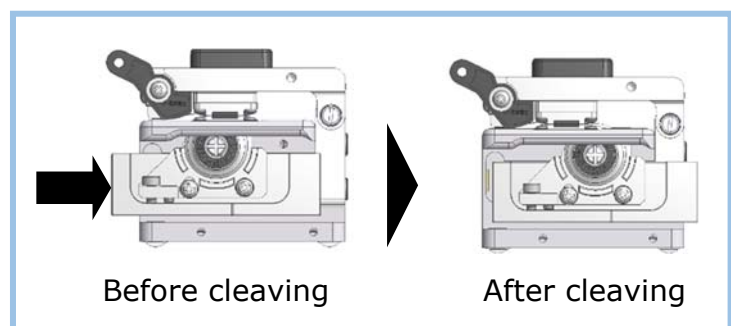

2. Basic splicing operation

5: Open the top clamp lever.

Then open the lid of the single fiber adapter and lift the newly cleaved fiber. Lift the off-cut and dispose it properly.

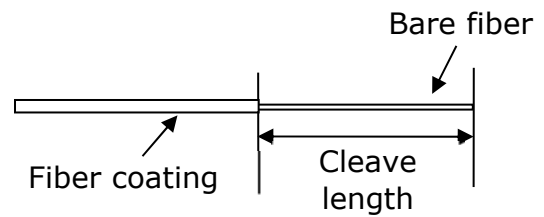

- 1: Do not re-clean the fiber after cleaving.
- 2: To avoid damaging or contaminating a delicate fiber end, insert the fiber in the splicer immediately after preparation.
- 3: Glass-fiber fragments are extremely sharp. Handle with care.

•By using fiber cleaver (FC-6S-5C), a cleave length of 5-20mm is available ($\phi 0.25\text{mm}$ & $\phi 0.9\text{mm}$). Please confirm the manual of fiber cleaver (FC-6S-5C) about detailed procedure.

2. Basic splicing operation

● Inserting fibers into the splicer

1: Open the hood and the fiber coating clamp lid.

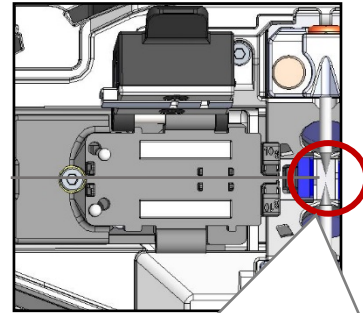

2: Place the fiber in the splicer so the fiber end is between the edge of the v-groove and the electrodes.

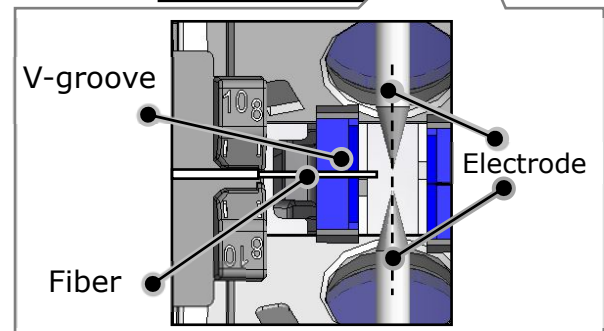

3: Close the fiber coating clamp lid.

Do not touch the fiber end face against any surface.

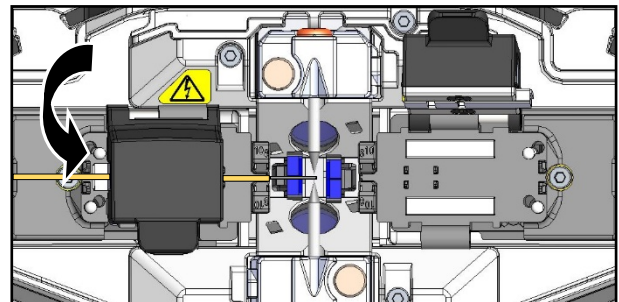

4: Repeat step 2 to 4 for the other fiber.

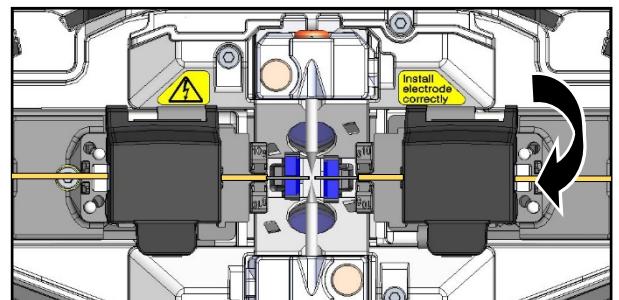

5: Close the hood.

6: Start an arc test or the splicing process.

2. Basic splicing operation

● Arc test

The fusion splicing is a method of melting and connecting the point of optical fiber by heat of electrical discharge. Since optimum arc conditions are different depending on the environments (atmospheric pressure and temperature) and the electrode conditions (wear-out and accumulation of the glass) and the optical fibers (manufacturer and SMF/MMF, etc.), an optimum arc condition is essential to achieve a low splice loss. Please perform an arc test before splicing in a typical splice program such as "SMF Standard".

Auto Mode which is incorporated in the TYPE-Q102-CA+ automatically analyzes and then calibrates an arc power at each splice. Normally an arc test does not need performing. However, **the arc test should be performed in the following situations.**

- Poor splice performance
(high or inconsistent splice losses, poor splice strength)
- After electrode replacement
- Extreme changes in temperatures, humidity or air pressure

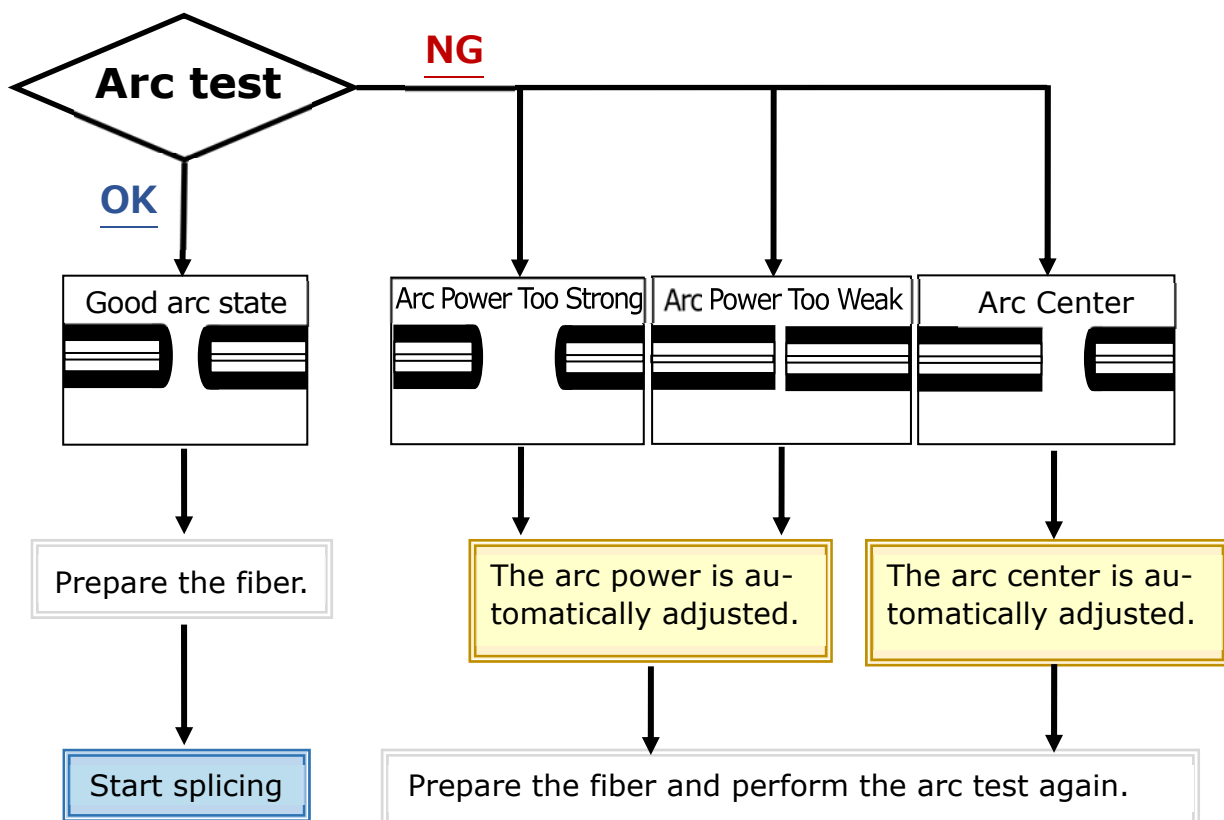

The adjusted arc power level is stored even if the splicer is turned off.

2. Basic splicing operation

■ Arc test procedure

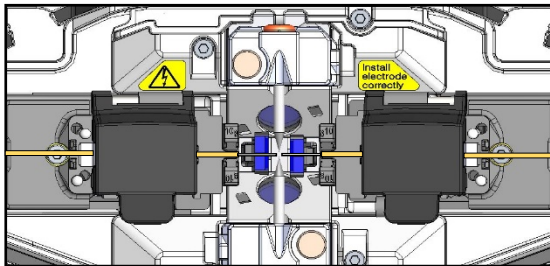



1: As mentioned in the previous pages, load a prepared fiber. (The coating is removed and fiber is cleaved.)

▶P.2-14 Inserting fibers into the splicer

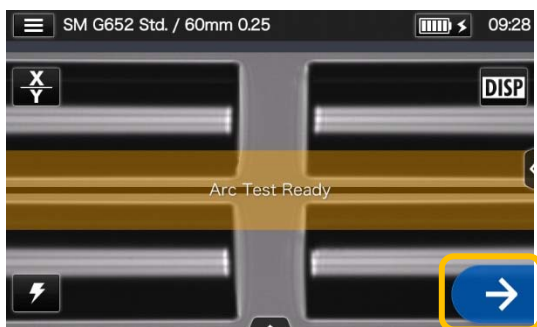

2: Tap Arc Test icon  .



3: After "Arc Test Ready" appears, tap the Set icon  or press the Set key  . An arc test is started.

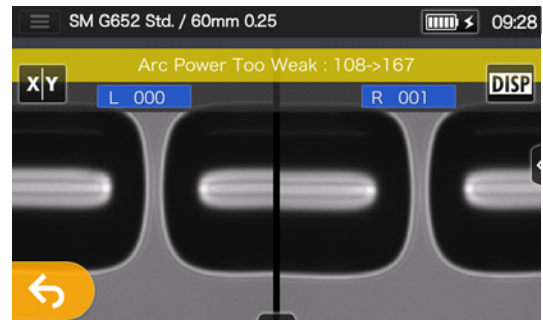

4: The melt back distance of the left and right fibers and the arc center position which are measured via image processing are displayed on the monitor screen. (The arc center position value is displayed only if the position is shifted.)

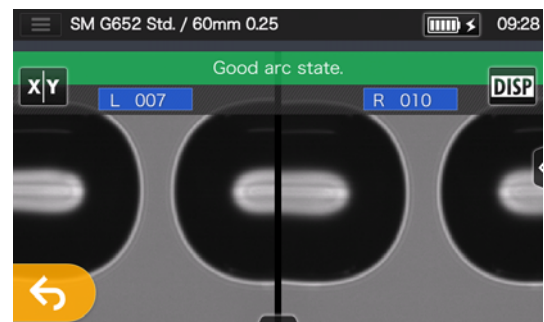

5: After "Good arc state." displayed, begin the fiber preparation procedure to perform a splice.

If "Arc Power Too Weak", "Arc Power Too Strong" or "Arc Center" is displayed, prepare the fiber again and repeat the test until "Good arc state." is displayed. (Refer to the previous page.)

2. Basic splicing operation

Starting the automatic splice

Here is a summary of the splicing operation procedures.

1: Slip a protection sleeve over the fiber.

2: Strip the fiber coating and clean the fiber. If you have performed an arc test, prepare the fiber again.

- ▶ P.2-11 Stripping the fiber coating
- ▶ P.2-12 Cleaving the fiber

3: Load a prepared fiber in the fiber coating clamp of the fusion splicer.
(▶P.2-14)

Tap the Set icon (→) or press the Set key (→) to start splicing.



Be sure to slip the fiber protection sleeve over one of the fibers to be spliced before stripping and cleaving the fibers. The fiber protection sleeve cannot be installed after splicing.

Making a splice



1: Tap the Set icon (→).

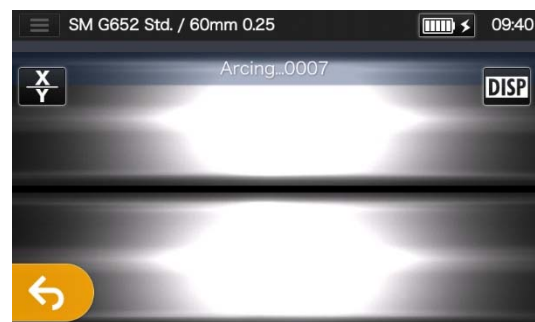

3: Arc is generated.

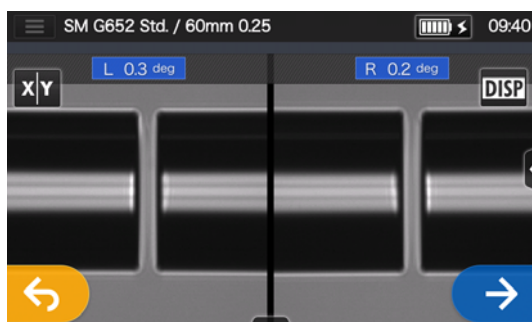

2: Inspection of fiber end face & dust.

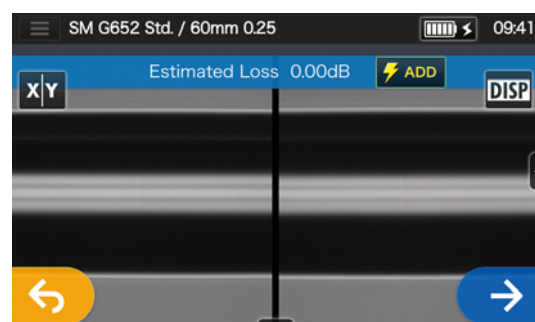

4: Estimated loss is displayed.

After the splicing process is complete,

▶Checking splice image and data P.2-18

▶Splice error possible cause and troubleshooting P.2-19





▶Proof test P.2-20

2. Basic splicing operation

■ Checking splice image and data



You can check and save image and/or text splice data at the arc pause stage or after splicing.

Tap the Control panel icon () . You can do the following actions.

	View splice data after splicing
	Adjust the zoom of a fiber image. (Available when X or Y is selected)
	Adjust display brightness.
	Capture a fiber image on the screen.
	Adjust the focus (Available when X or Y is selected)

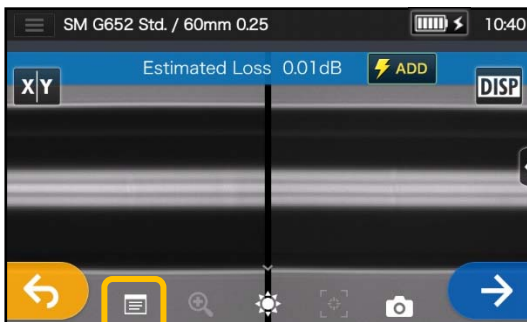
Checking splice data and taking a memo



1: After splicing, tap the Splice data details icon () on the Control panel () .



2: View and check splice data.

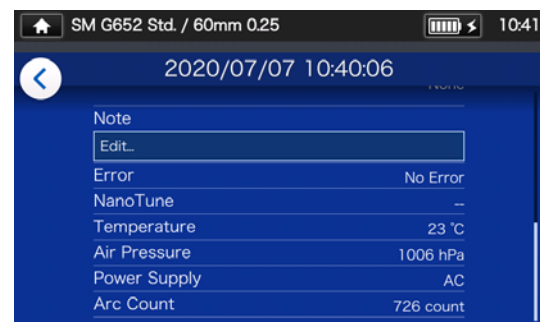







3: Add a memo by tapping the Memo icon.

► **View splice data P.6-8**

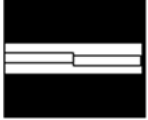
2. Basic splicing operation

■ Splice error possible cause and troubleshooting

Do a visual check of the splice point viewed on the monitor. If any symptoms below appear or an estimated loss is too high, read the troubleshooting against the symptom and re-do the entire splicing procedures from the beginning.

Symptom	Possible cause	Troubleshooting	Refer to
Kink or offset 	There is dust on the V-groove and bare fiber pads.	Clean the V-groove and bare fiber pads. ▶See the illustrations below.	▶P.3-1 Cleaning V-grooves, P.3-2 Cleaning bare fiber pads
	Arc power is not optimum.	Perform an arc test to make sure the splicer gives "Arc OK".	▶P.2-15 Arc test
	The melt back distance is not equal between the left and right fibers.		
Bulging 	Overlap is too big.	Decrease the Overlap.	▶P.4-6 Splice program editable items
	Arc power is not optimum.	Perform an arc test to make sure the splicer gives "Arc OK".	▶P.2-15 Arc test
	There is dust on the V-groove and bare fiber pads.	Clean the V-groove and bare fiber pads.▶ See the illustrations below.	▶P.3-1 Cleaning V-grooves, P.3-2 Cleaning bare fiber pads
Neck-down 	Overlap is too small.	Increase the Overlap.	▶P.4-6 Splice program editable items
	Arc power is not optimum.	Perform an arc test to make sure the splicer gives "Arc OK".	▶P.2-15 Arc test
	There is dust on the V-groove and bare fiber pads.	Clean the V-groove and bare fiber pads.▶ See the illustrations below.	▶P.3-1 Cleaning V-grooves, P.3-2 Cleaning bare fiber pads
Bubble 	Prefusion time is too short.	Increase the Prefusion time.	▶P.4-6 Splice program editable items
	There is dust on the fiber.	Cleave the fiber again.	▶Instruction manual that came with the cleaver you use.
	The cleave angle of the fiber exceeds the allowable limit.		
White line 	Arc power is not optimum.	Perform an arc test to make sure the splicer gives "Arc OK".	▶P.2-15 Arc test
	Prefusion time is too short.	Increase the Prefusion time.	▶P.4-6 Splice program editable items
Black line 	There is dust on the fiber.	Cleave the fiber again.	▶Instruction manual that came with the cleaver you use.

Cleaning V-groove and bare fiber pads



A white line, black line or vertical line appears at the splice point when MMF, dissimilar fibers or fibers with different diameters are spliced. But it does not affect splice quality, such as splice loss, tensile strength, and etc.

2. Basic splicing operation

● Proof test

After fusion splicing is complete, the splicer performs a proof test to verify the tensile strength of the splice.

Open the hood or tap the Set icon to start the proof test. (Once started, the proof test cannot be cancelled.)

Automatic proof test

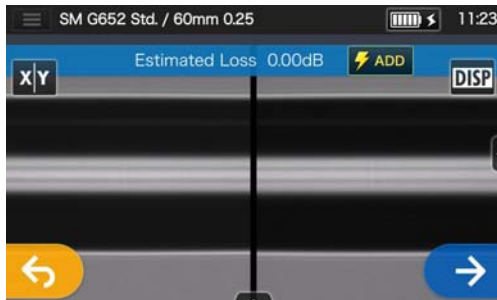

1: Open the hood.

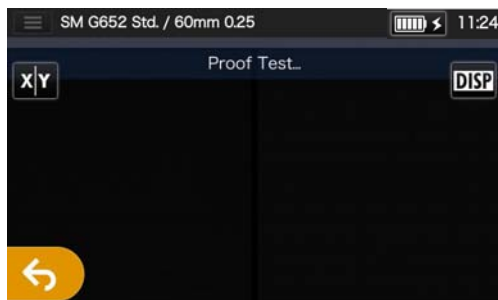

2: The proof test is automatically started.

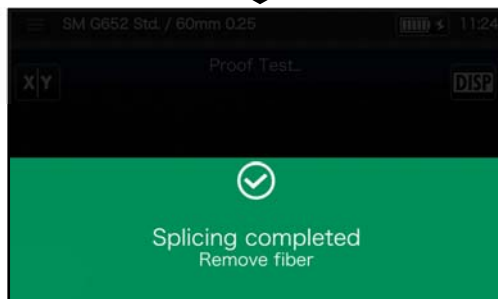

Manual proof test

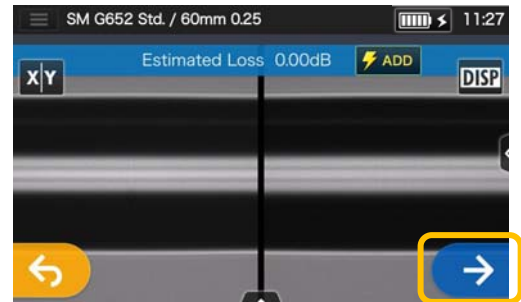

1: Tap the Set (→) icon.



2: The proof test is started.

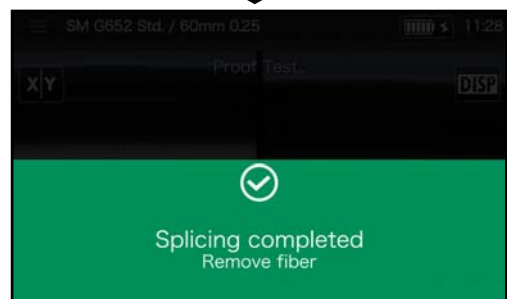

When the proof test is complete, the screen as shown above is displayed. ▶ Proceed with the heating process. See the next page.



Take care to keep the spliced fiber straight. Do not flex it back and forth. Doing so will cause the spliced fiber to be broken, resulting in loss of the long term reliability of the fiber.

2. Basic splicing operation

● Splice protection

1: Open the heat shrink oven lid and the heat shrink oven clamps.
(▶P.7-5 Heater clamp operation)

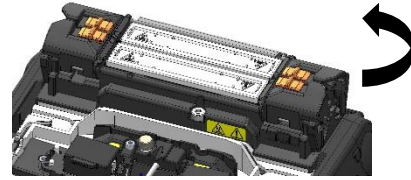

2: Open the hood and the fiber coating clamps. Take out the spliced fiber. Do not flex and bend it.

Slide the protection sleeve (▶P.2-17 ) over the center of the splice.

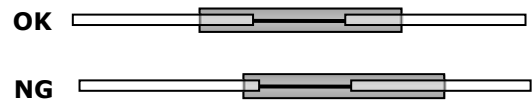



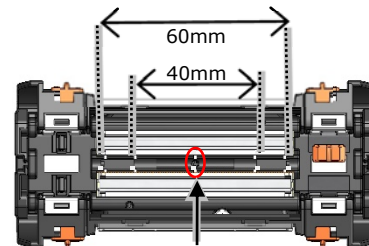

3: While keep applying a slight tension to the left and right fibers, lower them onto the heat shrink oven. The oven lid and oven clamps close accordingly.



Marking for the center of the heat shrink oven

When lowering the fiber onto the heat shrink oven, use the markings on the heat shrink oven as a reference.

4: Press the Heater key () or tap the Heater icon ().
The heat cycle is started.
If you would like to cancel the heating process, press the Heater key () or tap the Heater icon () again.

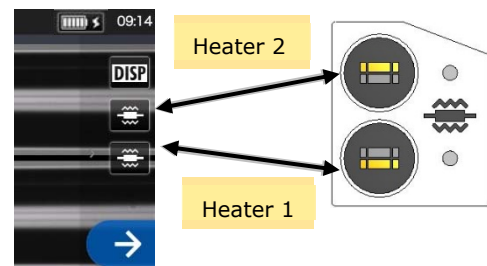

If Auto start heating is set to ON, the heating operation is automatically started when the fiber is placed into the heat shrink oven.

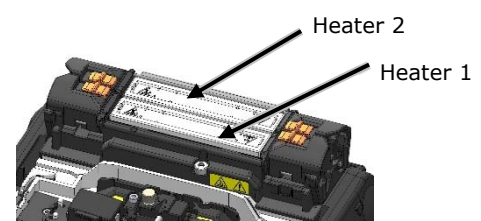

2. Basic splicing operation

5: The Heater progress bar shows a progress of the heating cycle. The splicer gives a beep sound indicating completion of the heating cycle. Take out the sleeve from the heat shrink oven after a beep sound is heard.

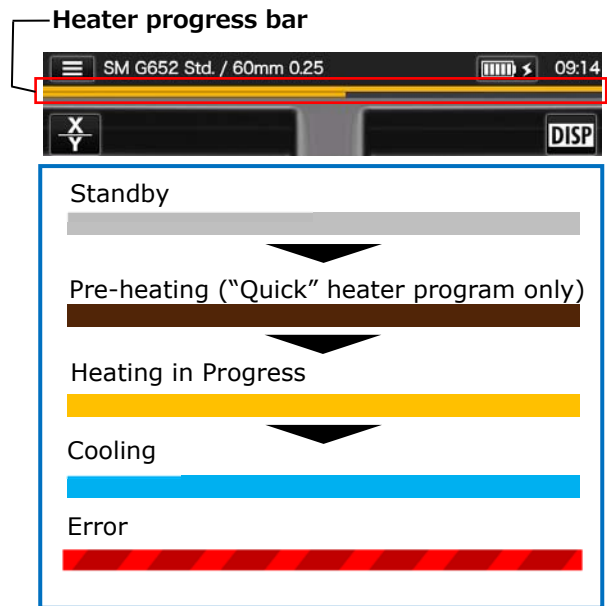

6: Place the protection sleeve onto the cooling tray.

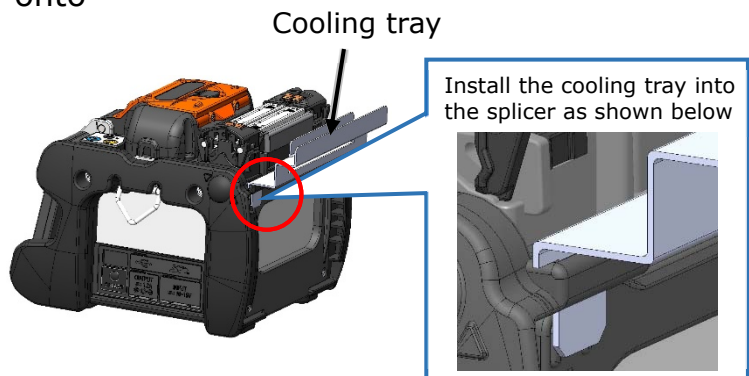

Caution.

If the sleeve is taken out from the oven before heat cycle completed, the splice loss might increase because the less cooling cause fiber bending or twisting. Please wait for the finish of heating cycle. After the heat cycle is complete, the fiber protection sleeve may be hot. Handle with care.

Never touch the surface of the heating plate during the heating operation. Doing so may cause personal injury and damage to the heat shrink oven.

Evaluating protection sleeve

NG

1: The shrinking sleeve is not centered over the splice. 3: Incompletely shrunk (trumpet end)

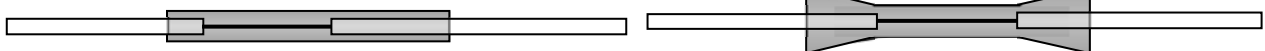

2: Bend in bare fiber

4: Bubbles on bare fiber

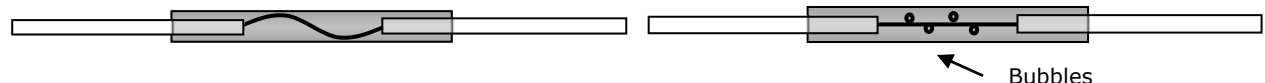

2. Basic splicing operation

Drop cable splicing

● Applicable cable

- Tight buffer type single fiber drop cable.

● Required items

- Fusion splicer (TYPE-Q102-CA+)
- Allen key 1.5mm
- Cross-recessed screwdriver
- Nippers
- Jacket remover
- Fiber cleaver
- Fiber holders for drop cable

● Preparation

<Fusion splicer>

- Using the allen key, remove the fiber coating clamp from the splicer.

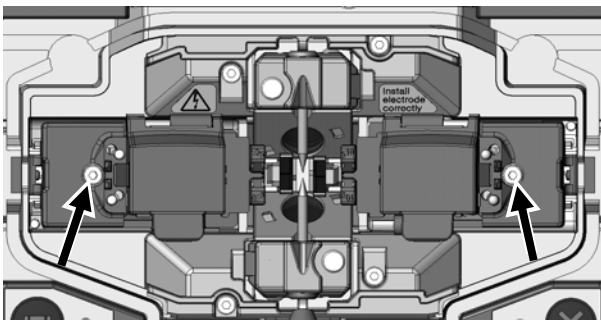

Factory default

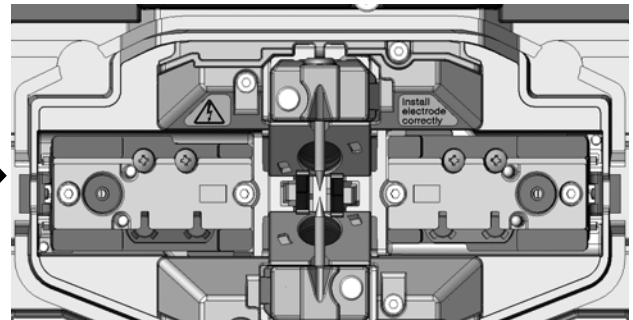

Fiber coating clamp is removed.

<Fiber cleaver>

- If the single fiber adapter AP-FC6M is attached to the cleaver, it must be removed.
- If the single fiber adapter AP-FC6SA is attached to the cleaver, it does not need to be removed and can be used as it is.

AP-FC6M

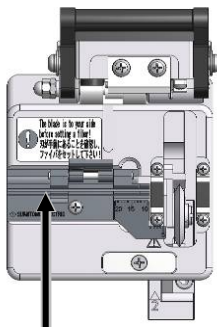

Groove for drop cable is not available.

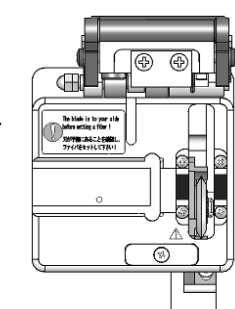

Remove the single fiber adapter.

AP-FC6SA

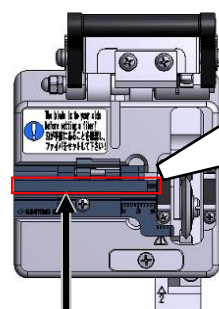

Groove for drop cable is available.

Groove for drop cable

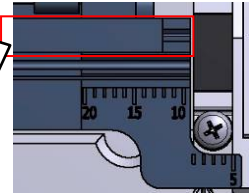

2. Basic splicing operation

● Removing cable sheath

Clean the cable sheath thoroughly to remove cable gel or other stains.

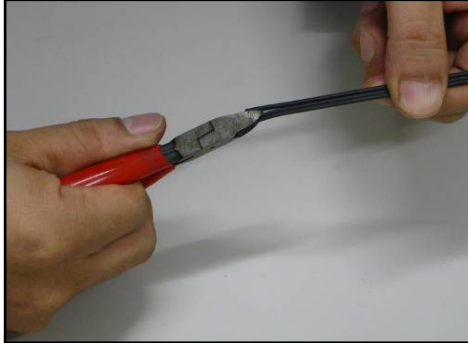

1: Separate the steel wire from the cable using nippers.



4: Make a slit along the groove of the cable sheath using nippers.

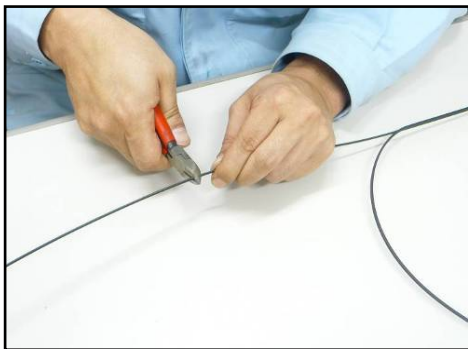

2: Cut the steel wire to a desired length.

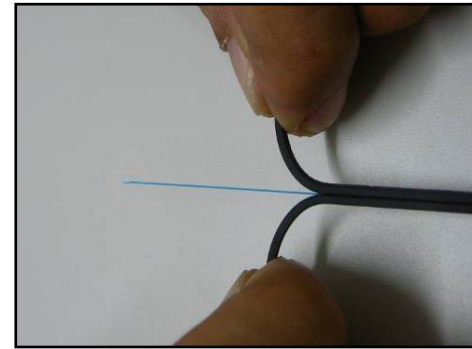

5: Split the cable sheath to expose 30~40mm of optical fiber. Cut off the split cable sheath.

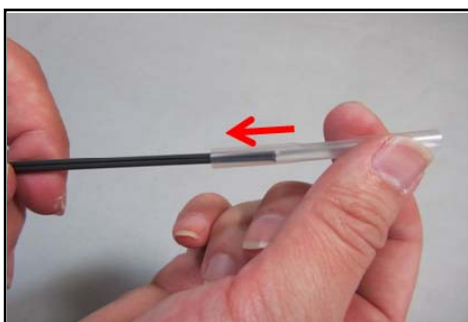

3: Insert a protection sleeve over the cable.

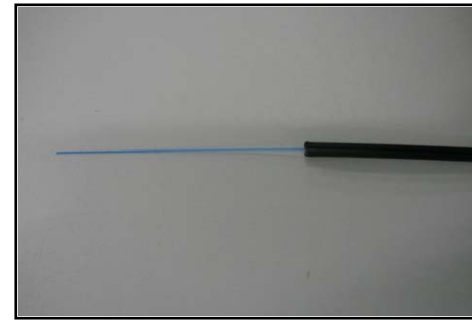

6: The cable sheath is removed. Repeat step 1 to 5 for the other cable. Cut each half of the cable sheath to the same length.



Take care not to damage the optical fiber when cutting the cable sheath.

2. Basic splicing operation

● Fiber preparation procedures 1 (AP-FC6SA is available)

This section outlines fiber preparation procedures in using a fiber cleaver with a single fiber adapter (AP-FC6SA). If your fiber cleaver does not have the single fiber adapter or a single fiber adapter attached to your cleaver is AP-FC6M, please refer to the procedures 2.

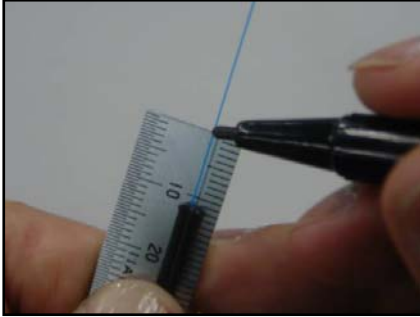

- 1: Put a mark at 10~12mm away from the cable end.

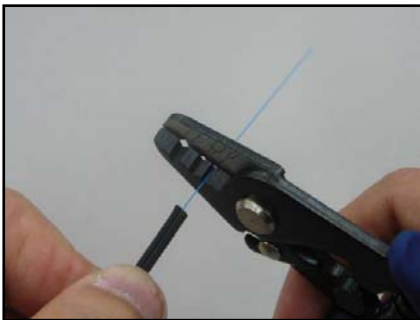

- 2: Remove the fiber coating from the mark using a jacket remover.



- 3: Clean the bare fiber from the end of the fiber coating with a gauze pad moistened with pure alcohol. Pull the bare fiber through the gauze pad and rotate the fiber to remove any coating residue.

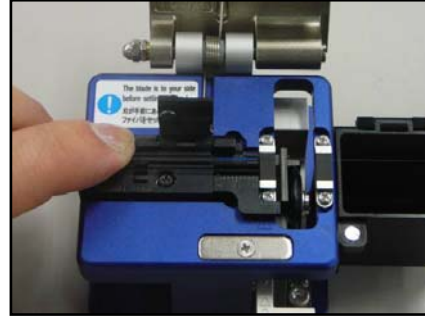

- 4: Place the cable in the groove for drop cable on the cleaver, aligning the cable end with the end of the single fiber adapter. Cleave the fiber referring to the cleaver instructions.

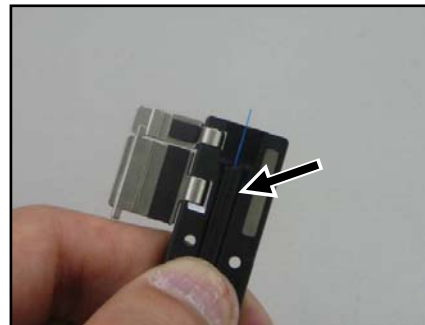

- 5: Load the cable in the fiber holder. Make sure that the cable sheath touches the groove. Close the bigger lid of the holder first, and then close the smaller lid.

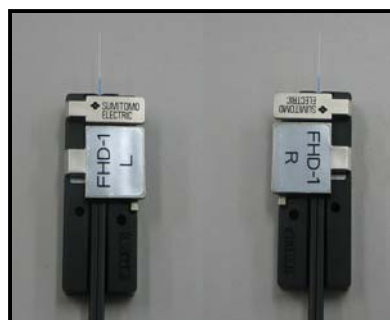

- 6: Repeat step 1~5 for the other cable.

2. Basic splicing operation

● Fiber preparation procedures 2 (AP-FC6SA is not available)

This section outlines fiber preparation procedures in using a fiber cleaver without single fiber adapter (AP-FC6SA). If AP-FC6SA is available, please refer to the procedures 1.

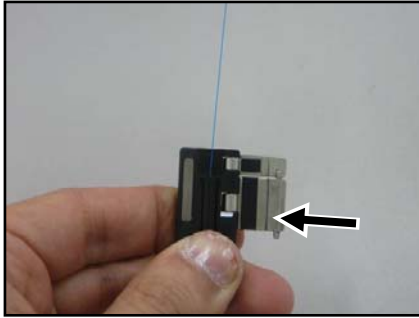

- 1: Load the cable with its sheath removed in the fiber holder. Make sure that the cable sheath touches the groove. Close the bigger lid of the holder first, and then close the smaller lid.

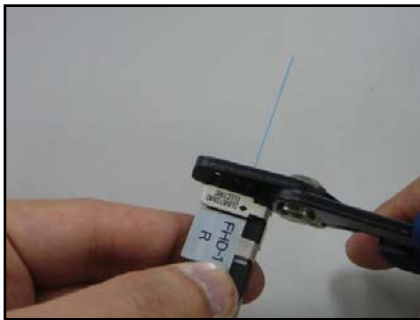

- 2: Remove the fiber coating at 2~4mm away from the edge of the fiber holder. (Touch the JR-M03 against the edge to remove, and you can remove the coating at 3mm away from the edge.)

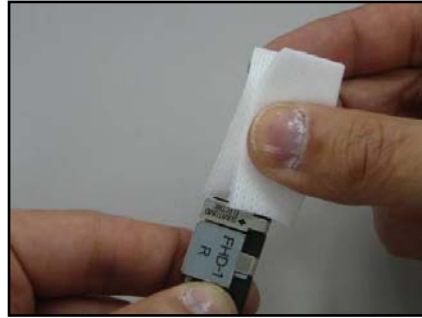

- 3: Clean the bare fiber from the end of the fiber coating with a gauze pad moistened with pure alcohol. Pull the bare fiber through the gauze pad and rotate the fiber to remove any coating residue.



- 4: Place the fiber holder in the cleaver, touching the edge of the fiber holder against the edge of the fiber holder receptacle. Cleave the fiber referring to the cleaver instructions.



- 5: Repeat step 1~4 for the other cable.

2. Basic splicing operation

● Inserting the fiber into the splicer



1: Open the hood.



2: Place the fiber holder onto the fiber holder stage, fitting the pin of the stage into the hole of the fiber holder.

Take great care not to touch the fiber end face against any surfaces.

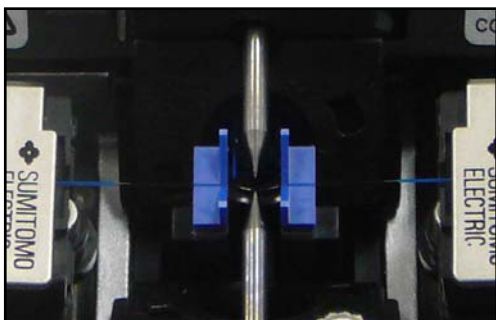

3: Make sure that the fiber sits in the V-groove correctly.



4: Close the hood.

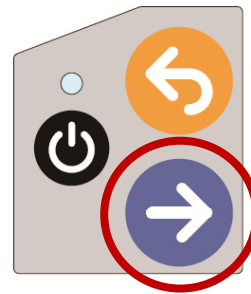

5: Start the splicing process.

- ▶ Perform an arc test prior to splicing.

For details on arc test and splicing procedures, please refer to the page below.

- ▶ P.2-15 Arc test
- ▶ P.2-17 Starting the automatic splice

2. Basic splicing operation

● Splice protection

1: Make the left hand oven clamp linked with the oven lid and the right hand oven clamp independent. Open the oven lid and oven clamps. Open the hood and all lids of the fiber holders.

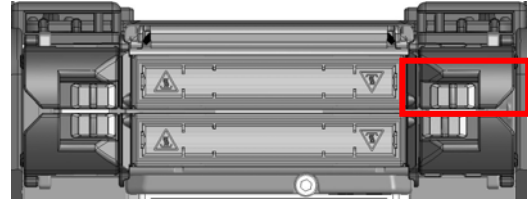

2: Take out the cable and slide the fiber protection sleeve onto the fiber. Make sure that the protection sleeve is centered over the splice and at least 5mm of the sleeve overlaps the cable sheath at each end of the splice.

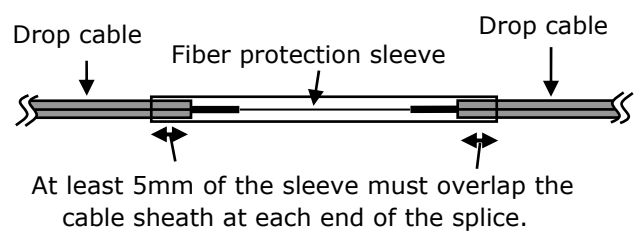

3: While maintaining a slight tension on the cable ends, transfer the cable to the heat shrink oven and close the right hand oven clamp.



Pay attention not to bend and flex the cable. Failure to do so can cause the splice to break.

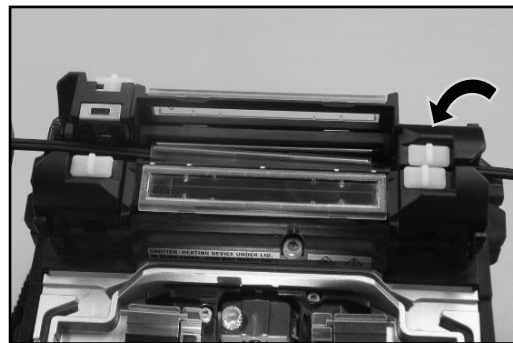

4: While applying a slight tension to the cable end, close the left hand oven clamp and oven lid. Start the heat shrink process.



While maintaining a slight tension on the cable ends, close the oven clamps.

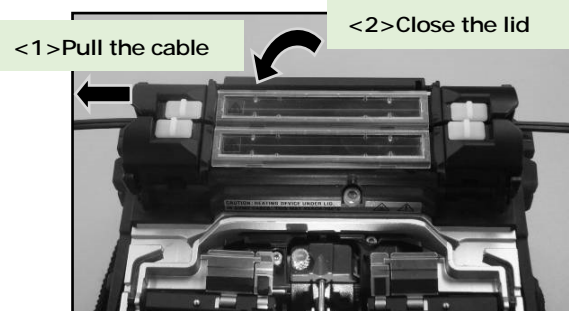

5: After the heat shrink process is complete, open the oven lid and oven clamps and take out the cable.

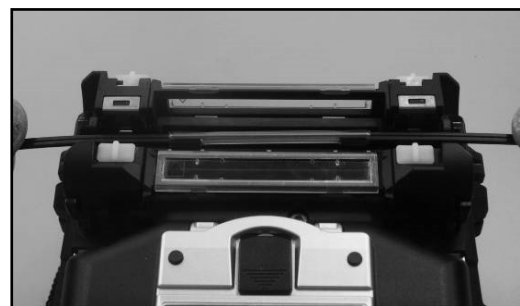

3. Maintenance

To keep excellent splice quality, regular cleaning and inspection are required. Especially cleaning should be performed before and after each use. We recommend your splicer to be checked through our maintenance service periodically.

Cleaning

Turn off the TYPE-Q102-CA+ before maintenance work. Clean each part with a cotton swab. Please bear in mind that daily cleaning can maintain splicer performance. Clean components before and after use.



Failure to do so may cause electric shock.

Cleaning V-grooves

Even tiny bits of dust or dirt in the V-grooves might cause the fiber to be offset. To avoid offset, carefully clean the V-grooves with a cotton swab moistened with alcohol.

V-grooves

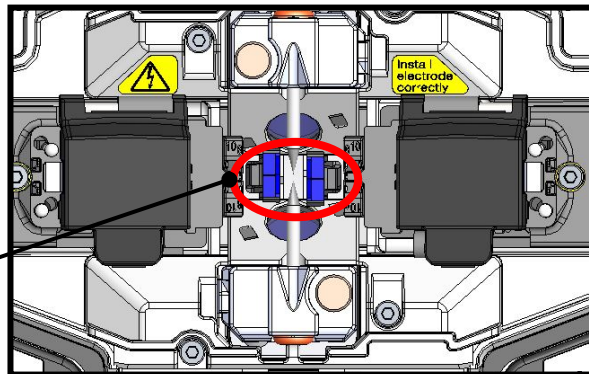

- 1: Prepare a cotton swab moistened with alcohol.
- 2: Brush the surface of the V-grooves in the direction of the arrow.

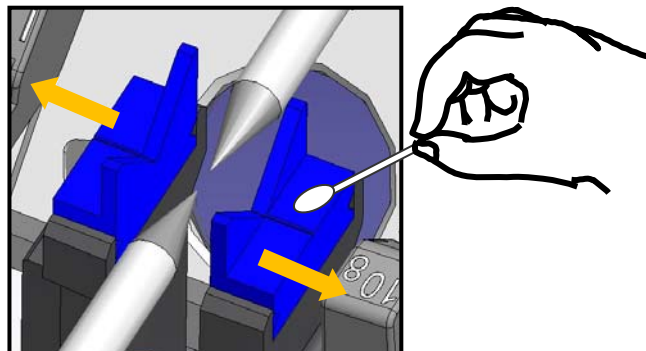

3. Maintenance

● Cleaning LEDs and bare fiber pads

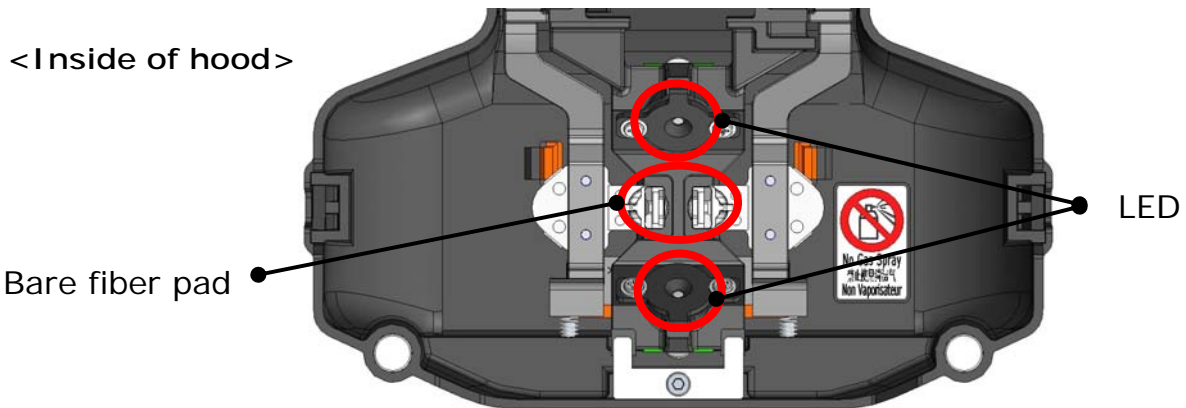

■ Cleaning bare fiber pads

Dirt on a bare fiber pad will cause the fiber to be offset. When fiber offset occurs, clean the bare fiber pad.

- 1: Prepare a cotton swab moistened with alcohol and wipe the surface of bare fiber pads.
- 2: Use a dry cotton swab to wipe off any excess alcohol.

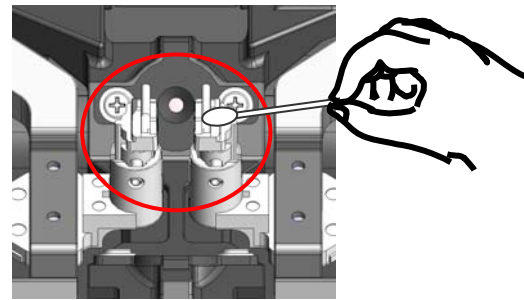

■ Cleaning LEDs

When a LED surface is dirty, a fiber image is unclear, resulting in imperfect image processing. If the display is uneven or LED error occurs, clean them with a cotton swab moistened with alcohol.

- 1: Prepare a cotton swab moistened with alcohol and wipe the surface of LED lightly.
- 2: Use a dry cotton swab to wipe off any excess alcohol.

*Do not apply too much force when cleaning.

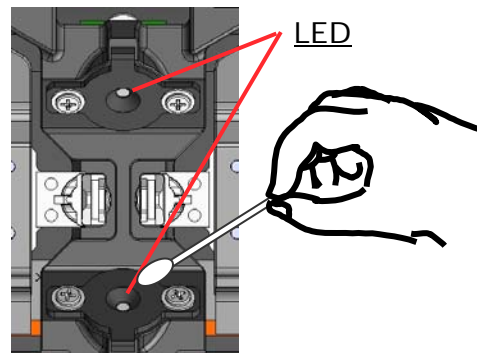

Prohibition

Do not use a canned air for cleaning. Chemical reaction may deteriorate the LED, resulting in a loss of splicing capability.



● Cleaning lens protection glass

If an unclear fiber image is still displayed or LED error occurs again after cleaning LEDs, clean the lens protection glass.

Lens protection glass

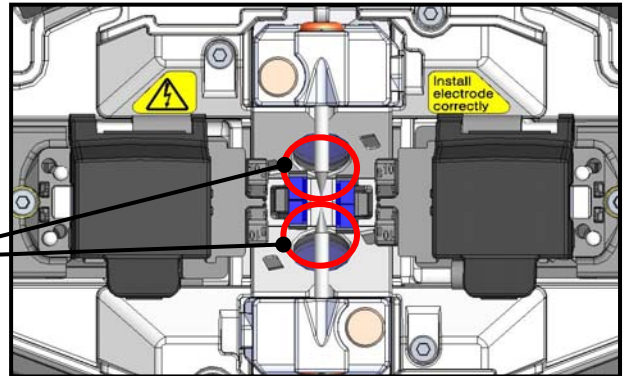

- 1: Remove the electrodes, referring to the "Electrode replacement procedures". ▶P. 3-6
- 2: Prepare a cotton swab moistened with alcohol.
- 3: Gently wipe the lens protection glass in a circular motion.
- 4: Use a dry cotton swab to wipe off any excess alcohol.
- 5: Re-fit the electrodes.
- 6: Perform an arc test.

*Do not apply too much force when cleaning.

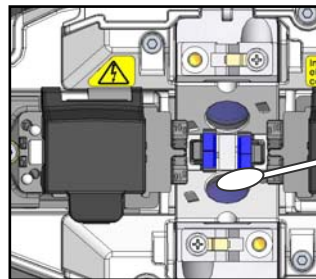
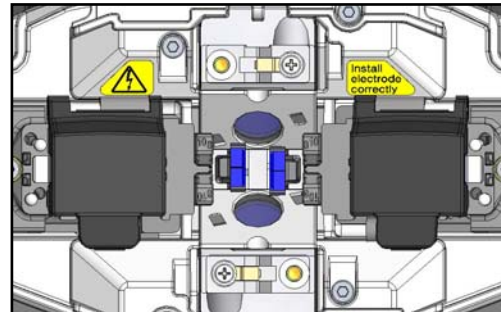

If splicing is carried out right after electrode replacement, the splicer cannot automatically adjust the arc center position, giving an error. Please be sure to perform an arc test first.

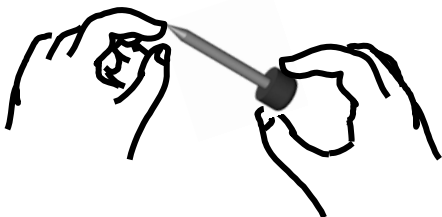

An electrode tip is extremely sharp. Handle with care.

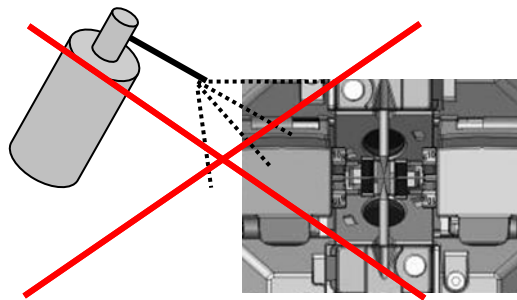

Do not use a canned air for cleaning. Chemical reaction may deteriorate the lens protection glass, resulting in a loss of splicing performance.

3. Maintenance

● Cleaning heat shrink oven

Dirt and dust can accumulate in the heat shrink oven easily. Clean the heating plate regularly with a dry cotton swab.

1: Clean the heating plate with a dry cotton swab.

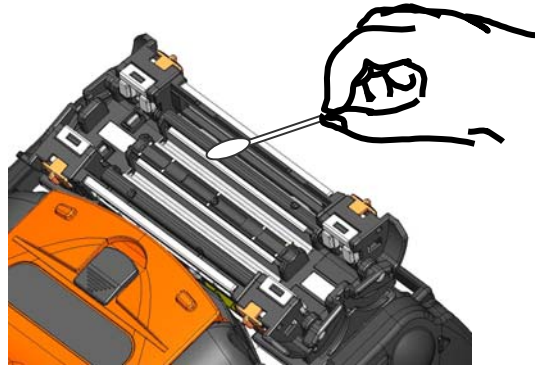

2: Clean the clamps of the heat shrink oven with a cotton swab moistened with alcohol.

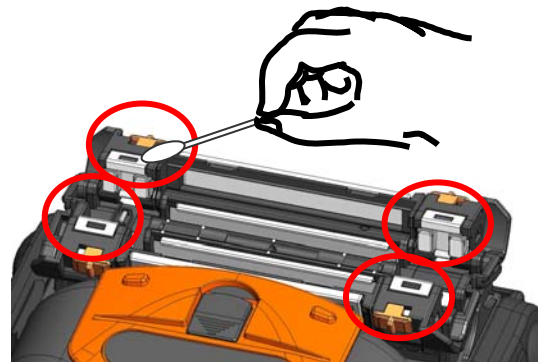

Caution

Remove moisture or alcohol on the heat shrink oven with a dry cotton swab.

Electrode replacement

Electrodes are worn out or contaminated due to silica glass evaporated during arc, and the electrode condition changes day by day. To achieve a repetitive and stable arc for excellent quality splicing, electrodes should be replaced periodically. Continuing to use the same electrodes may result in high splice losses and poor splice strength.

On the TYPE-Q102-CA+, electrodes typically need replacing after approximately 6,000 arc discharges.

If the number of arc discharge exceeds 5,000, Arc Count on the screen will be highlighted in yellow for warning, with a message "Electrodes need changing soon".

If the number exceeds 6,000 times, a warning message appears every time the splicer is powered on and until you replace electrodes according to the replacement procedures described in the next page.

Always replace with Sumitomo genuine electrodes in pairs at a time. Failure to do so can keep the splicer from maximizing its ability.

*The arc count at which the Caution/Warning message appears can be edited in Administrator mode. ▶P. 6-8 Maintenance settings



Caution

Precautions on electrode replacement

- Be sure to turn off the splicer and unplug the power cord or remove the battery pack before replacing the electrodes.
- An electrode tip is extremely sharp. Handle with care.
- When handling the electrodes, avoid touching the electrode tips with anything.
- Do not clean the electrode. Doing so may cause unstable arcing performance.
- Discard the old electrodes properly.

3. Maintenance

● Electrode replacement procedures

- 1: Disconnect the power cord or remove the battery from the splicer if installed.

 Failure to do so can cause electric shock.

- 2: Using your fingers, loosen the thumbscrew.

- 3: Take out the electrode and electrode cover from the splicer. Remove the electrode from the electrode cover by pulling it out straight.

- 4: Fit a new electrode in the electrode cover.

- 5: Insert the protrusion of the electrode cover in the splicer. While keep pushing down the cover, tighten the thumbscrew fully. ▶Refer to the illustrations below.

- 6: Repeat step 2 to 5 for the other electrode. Always replace both electrodes at a time.

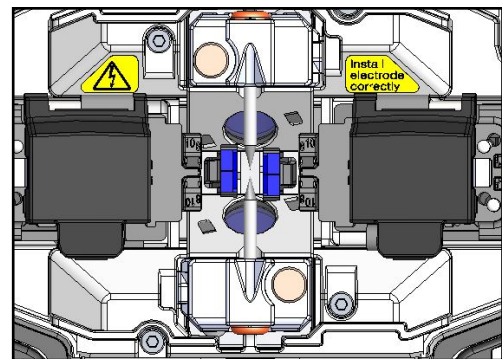
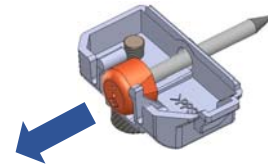
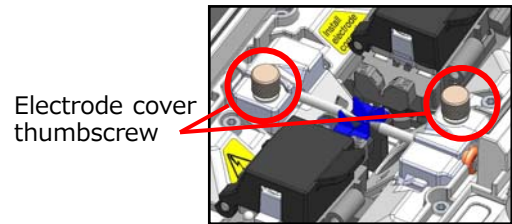
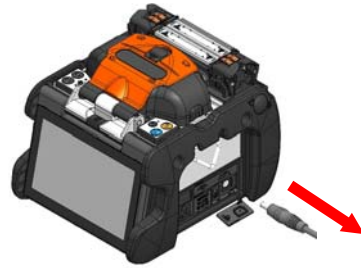

Insert the protrusion of the electrode cover in the splicer, and then fit in the cover.

Protrusion

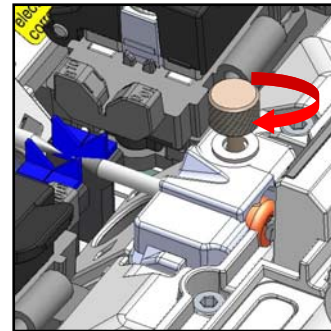
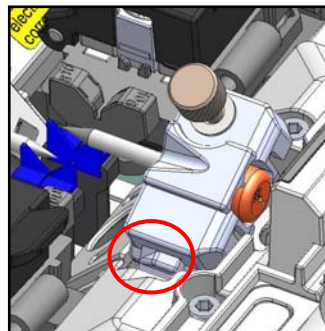
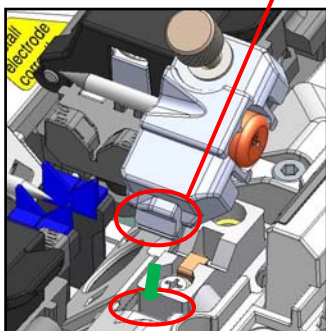

3. Maintenance

Splice performance is not stable or the splicer partly gets damaged if the electrodes are installed in a wrong way.

Make sure....

- The protrusion of the electrode cover fits in the splicer properly.
- The tips of the electrodes face each other at the same height.
- The thumbscrew of the electrode cover is tightened completely.

Example:

< Incorrect >

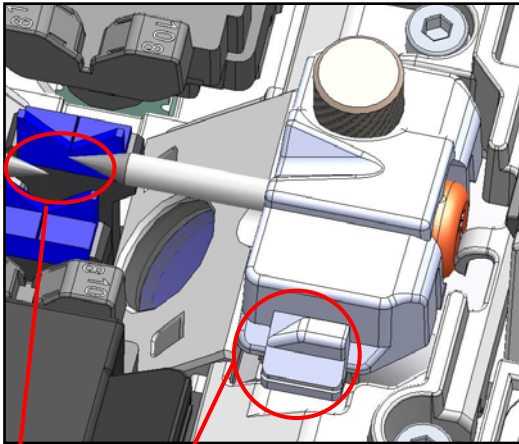

< Correct >

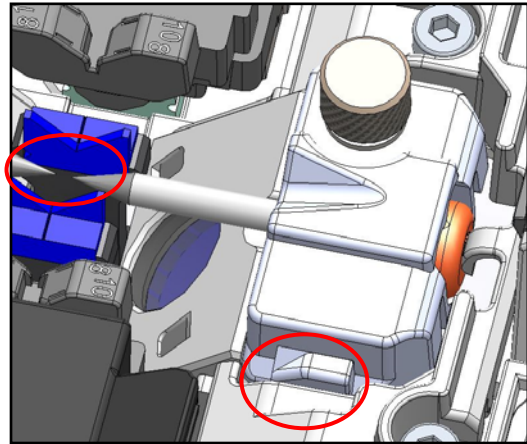

The protrusion does not fit in the splicer.

The electrodes are not at the same height.

Packing and storage instructions

The TYPE-Q102-CA+ fusion splicer is a precision instrument. Its rugged shipping case is custom designed to protect it from impact, dust, dirt, and moisture. Always store and transport the machine in its case.

- Store the TYPE-Q102-CA+ and its accessories in a designated place in the case referring to the photo below.
- Store the TYPE-Q102-CA+ in the direction shown in the photo below.
- The TYPE-Q102-CA+ with a cooling tray cannot be stored in the case. Remove the cooling tray from the splicer and store it in the pocket.

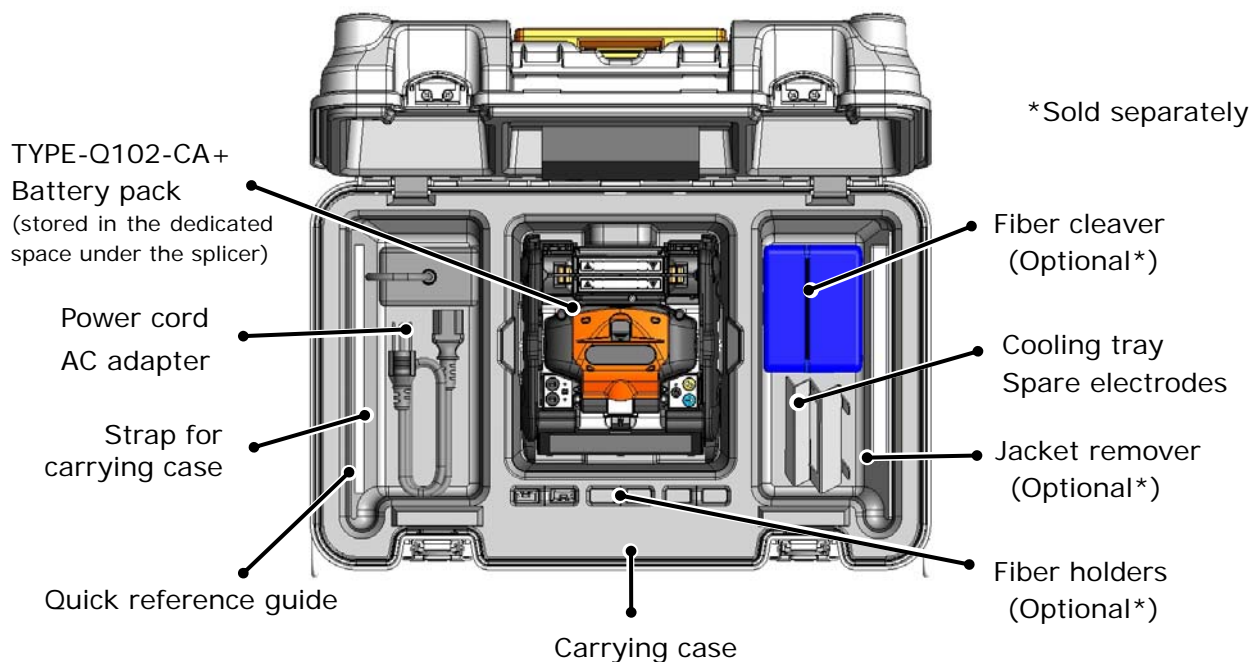

Observe the following instructions.

- Clean the TYPE-Q102-CA+ and all accessories before storing them.
- Be sure to remove the battery pack from the TYPE-Q102-CA+ and store it in the dedicated space located under the splicer.
- Reposition the monitor before storing.
- Discard the liquid solvent properly, or lock the dispenser completely and put it in a plastic bag before packing the dispenser in the case.
- Before storing the fiber cleaver, dispose of the fiber fragments collected in the off-cut collector in a proper way.
- Close the carrying case completely and latch it before transportation.
- Pay attention to storage temperature and dew condensation when storing the splicer. The battery is self-discharged during storage. Perform temperature control and charge and discharge the battery once every 6 months.

Storage temperature -20°C ~ +50°C (if stored for less than 1 month)

-20°C ~ +40°C (if stored for less than 3 months)

-20°C ~ +20°C (if stored for less than 1 year)



- Keeping the battery in the TYPE-Q102-CA+ may cause the battery terminal to be damaged or deteriorated, resulting in fire.
- Take extreme care of the handling of alcohol.
- Glass fiber fragments are extremely sharp. Handle with care.

Software update via internet

If you obtain maintenance application via the URL below, you can update splicer software via internet. For further information, please access the URL below and refer to a dedicated manual.

https://global-sei.com/sumitomo-electric-splicers/support/firmware_update/

- Software update
The splicer software can be updated via internet
- Remote maintenance (* 1)
The splicer can be remotely inspected via internet.
* 1 : Remote maintenance are not covered in some countries and regions. For more information, please contact your sales representative.

4. Splice program

Splice program list

The product has splice programs pre-installed as a template. The programs are optimized according to the optical fiber profiles. (▶P.2-9 Selecting splice program)

AUTO Mode

Splice program	Details
AUTO NanoTune	<p>Splicing can be performed by using not only the existing AUTO mode function but the new NanoTune™ technique.</p> <p>The NanoTune™ analyzes a fiber end face and automatically fine-tunes splice condition to achieve an ideal splice.</p> <p>Coping with poorly cleaved optical fiber, which cannot be spliced by conventional splicers, the NanoTune™ can yield the best quality and low loss splices.</p> <p>When the NanoTune™ is activated, a dedicated splice screen appears.</p> <p>NanoTune™ enables to splice standard SMF (ITU-T G.652) and BIF (ITU-T G.657). (▶P.4-9 NanoTune™ splice mode)</p>
AUTO	<p>Using Auto fiber Profiling check and Detection System (APDS*1), the splicer recognizes the type of a fiber loaded, automatically chooses the splice program that matches the fiber, followed by splicing. Auto mode enables to splice standard SMF (ITU-T G.652), MMF (ITU-T G.651), DSF (ITU-T G.653), CSF (ITU-T G.654), NZDSF (ITU-T G.655), and BIF (ITU-T G.657). The recognized fiber type is displayed below a fiber image on the monitor.</p> <div style="border: 1px dashed black; padding: 10px;"> <p>ATTENTION</p> <ul style="list-style-type: none"> • The recognizable fiber types are standard SMF, MMF, DSF, CSF, NZDSF, and BIF. • DSF is recognized as NZDSF. • Fibers other than SMF, MMF, DSF, CSF, NZDSF, and BIF are recognized as Others. • Left and right fibers are recognized individually. • The splicer stores data on representative core profiles of standard fiber types. However it may sometimes incorrectly recognize other manufacturers' fibers and new design fibers. In this case choose a suitable splice program by yourself. • Even if fibers are sorted in the same category, suitable splice program is sometimes different depending on the manufacturers or fibers. In this case choose a suitable splice program by yourself. </div>
SM G652 Auto	Can be used to splice identical SMF (ITU-T G652). Choose the program when you clear on the type of the fiber being spliced.
MM G651 Auto	Can be used to splice identical MMF (ITU-T G651). Choose the program when you clear on the type of the fiber being spliced.
DS G653 Auto	Can be used to splice identical DSF (ITU-T G653). Choose the program when you clear on the type of the fiber being spliced.
CS G654 Auto	Can be used to splice identical CSF (ITU-T G654). Choose the program when you clear on the type of the fiber being spliced.
NZ G655 Auto	Can be used to splice identical NZDSF (ITU-T G655). Choose the program when you clear on the type of the fiber being spliced.
BIF G657 Auto	Can be used to splice identical BIF (ITU-T G657). Choose the program when you clear on the type of the fiber being spliced.

*1: The splicer automatically recognizes the type of optical fiber loaded via image processing, checks if a selected splice program matches the fiber, and displays the recognition result on the monitor. This system prevents an operator from splicing with an incorrect splice program.

4. Splice program

Standard Mode

Perform an arc test before splicing in standard mode splice programs.

(▶P.2-15 Arc test)

Category	Splice program	Details
SMF G652	SM G652 Std.	Can be used to splice identical standard SMF (ITU-T G.652).
	SM G652 Quick	Can be used to splice identical standard SMF (ITU-T G.652) and make a faster splice. In this mode APDS is disabled.
	SM G652 AIAS	Automatic Intentional Axis Shift (AIAS*2) enables to splice identical standard SMF (ITU-T G.652) with high core-cladding eccentricities.
	Other SMF	The splice programs including standard SMF (ITU-T G.652) are listed.
	SM ATTN1	This mode intentionally creates a high splice loss by shifting the centers of left and right fibers. A displayed estimated splice loss may not match actual splice loss depending on the type of the fiber being spliced. It is recommended actual splice losses should be measured using power meter. <ul style="list-style-type: none"> Recommended attenuation range: 0.1~5.0dB Target Loss: Enter a target splice loss in the splice program settings screen. Editable attenuation range is 0.1~15dB (in increments of 0.1dB) ATTN coef.: If the target splice loss does not match the actual splice loss, edit this value.
MMF G651	MM G651 Std.	Can be used to splice identical standard MMF (ITU-T G.651).
	MM G651 Quick	Can be used to splice identical standard MMF (ITU-T G.651) and make a faster splice. In this mode APDS is disabled.
	Other MMF	The splice programs including standard MMF (ITU-T G.651) are listed.
DS G653	DS G653 Std.	Can be used to splice identical standard DSF (ITU-T G.653).
	DS G653 Quick	Can be used to splice identical standard DSF (ITU-T G.653) and make a faster splice. In this mode APDS is disabled.
	Other DSF	The splice programs including standard DSF (ITU-T G.653) are listed.
CSF G654	CS G654 Std.	Can be used to splice identical standard CSF (ITU-T G.654).
	Other CSF	The splice programs including standard CSF (ITU-T G.654) are listed.
NZ G655	NZ G655 Typ.	Can be used to splice identical standard NZDS (ITU-T G.655).
	NZ G655 Quick	Can be used to splice identical standard NZDS (ITU-T G.655) and make a faster splice. In this mode APDS is disabled.
	Other NZDSF	The splice programs including standard NZDS (ITU-T G.655) are listed.
BIF G657	G657 adaptive	Can be used to splice identical standard Bend Insensitive SM fiber: BIF (ITU-T G.657). This mode helps splice optical fiber with complicated core profile.
	G657 Quick	Can be used to splice identical standard BIF (ITU-T G.657) and make a faster splice. In this mode APDS is disabled.
	Other BIF	The splice programs including standard BIF (ITU-T G.657) are listed.
SPF	–	Splice programs for special fiber such as EDF, photonic fiber which are not categorized in the other splice programs are listed.
Recent	–	Recently selected splice programs are listed.

*2: High core-cladding eccentricities have an effect on surface tension during an arc, giving high splice losses. To minimize the effect, this method intentionally shifts the centers of the cores of left and right fibers when splicing.

4. Splice program

Customizing splice program

Splice program can be customized as per your requirement by editing parameters set in the program.



1: On the "Splice Program screen" (▶ P.2-9), select the fiber category where you would like to change the settings.



2: Tap the Pencil icon (✎) at the right upper corner of the screen.



3: Select the splice program you would like to edit.

An editable item has a > mark (➤) at the rightmost part of the row.

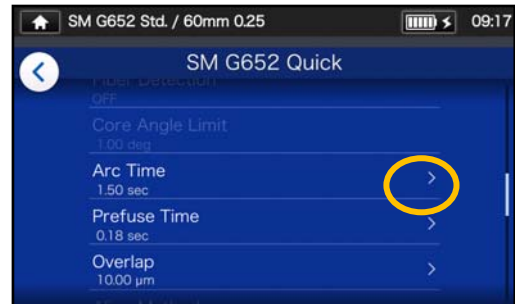

4: Select the item you would like to edit.



5: Delete the current value using ✕ icon first, and then edit the value and tap Done (Done).
*Std: is the default value.

Small pencil icon (✎) appearing at the upper right-hand corner of item names

In the above example, Arc Time is changed to 1.60 sec from the default 1.50 sec. After the default value of an item has been changed, a small pencil icon (✎) appears at the upper right-hand corner of the item name, enabling a user to understand the default value has been changed.

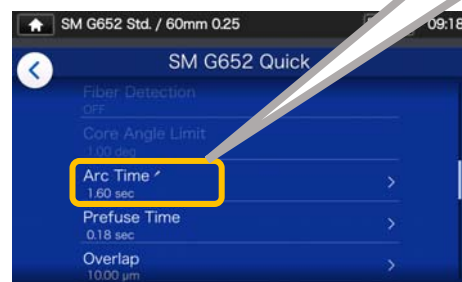

4. Splice program

Copying splice program (in Administrator mode)

In Administrator mode, you can create your own new splice program by copying an existing splice program to a blank area of splice programs. After the copy, you can edit the name of the copied program and change the parameter settings.

First, log in to Administrator mode to do this action.

(▶P.8-1 Logging in to and logging out of Administrator mode)



1: On the "Splice Program screen" (▶P.2-9), select the fiber category where you would like to change the settings.



Splice Program edit screen

2: Tap the Pencil icon (✎) at the right upper corner of the screen.



3: Tap (⚙️). A pull-down menu appears. Select Copy (📄 Copy) from the pull-down menu that appears.

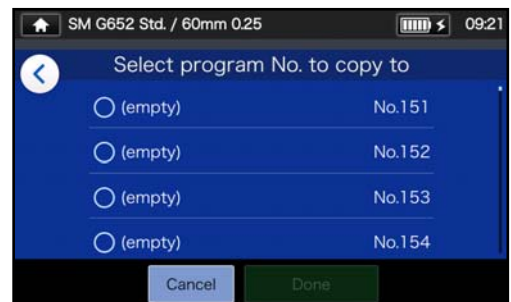

4: Select the program you want to copy and tap Done (Done). Next, select where you want to paste the copied program and tap Done (Done).



5: You can edit the name of the copied program and change the parameter settings.

▶P.4-3 Customizing splice program

An editable item has a > mark (➤) at the rightmost part of the row.

4. Splice program

Showing /Hiding splice program (in Administrator mode)

An administrator can show or hide splice programs in the Operator mode. First, log in to Administrator mode to do this action.

(▶P.8-1 Logging in to and logging out of Administrator mode)



1: Referring to the procedures in Page 4-4, go to "Splice Program edit screen". Tap the Pencil icon at () at the right upper corner of the screen.



3: After  is selected, the selected splice program will be hidden in the Operator mode.



2: Tap   to switch between ON⇌OFF.

▶P.5-5: Showing/Hiding heater program



The splice program which is currently selected for us cannot be hidden. To hide the program, first select other program to deselect the program, and then do the above procedures.

Once the program is displayed in the Operator mode, it is still saved after the power is switched off.

4. Splice program

Splice program editable items 1/2

Editable items	Details	Operator		Administrator	
		View	Edit	View	Edit
Name	Allows to edit splice program name	✓	-	✓	✓
Abbreviated name	Allows to edit heater program name which is displayed on the main splice screen.	✓	✓	✓	✓
Template	Views an original Splice Program which was copied.	✓	-	✓	-
Note	Allows to add a note to the selected splice program. (up to 21 characters)	✓	✓	✓	✓
Arc Power	Sets the arc power. Generally it is automatically set by an arc test and does not need to be changed. It is displayed as [Standard + XX] and [Standard] represents the arc power which has been set. [+ XX] can be manually edited.	✓	✓	✓	✓
Auto Arc Power	Automatically optimizes arc power. (Select ON⇔OFF)	✓	-	✓	✓
Gapset Position	Sets the position of splicing fibers. Generally it is automatically set by an arc test and does not need to be changed.	✓	✓	✓	✓
Cleaning Arc Time	Sets the time for cleaning arc to remove dust on optical fiber.	✓	-	✓	✓
Gap	Sets the gap between fiber end faces before arc fusion.	✓	✓	✓	✓
Cleave Angle Limit	Sets the threshold of cleave angle. If a reading exceeds the threshold, the splicer will give an error.	✓	-	✓	✓
Fiber Detection	Automatically recognizes optical fiber loaded. If the selected splice program does not match the fiber, the splicer shows a message on the monitor. (Select ON⇔OFF)	✓	-	✓	✓
Core Angle Limit	Sets the threshold of core angle. If a reading exceeds the threshold, the splicer will give an error.	✓	-	✓	✓
Arc Time	Sets the arc fusion time	✓	✓	✓	✓
Prefuse Time	Sets the time between start of arc fusion and feeding of fibers.	✓	✓	✓	✓
Prefuse Power	Sets the power for pre arc fusion.	-	-	✓	✓
Overlap	Sets the distance of feeding fiber.	✓	✓	✓	✓
Fiber Pulling	ON or OFF the action of pulling fiber after overlapping fiber.	-	-	✓	✓
Fiber Pulling Start*	Sets the time of pulling fiber.	-	-	✓	✓
Fiber Pulling Length*	Sets the distance of pulling fiber.	-	-	✓	✓
Fiber Pulling Speed*	Sets the speed of pulling fiber.	-	-	✓	✓

*Appears when Fiber Pulling is set to ON.

4. Splice program

Splice program editable items 2/2

Editable items	Details	Operator		Administrator	
		View	Edit	View	Edit
Align method	Sets fiber alignment method. Choose from "Core", "Diameter" and "Adaptive". "Core"...Aligns the center of the cores of right and left optical fibers. "Diameter"...Aligns the center of the diameters of right and left optical fibers. "Adaptive"...is useful in splicing optical fiber with complicated core profile.	✓	-	✓	✓
AIAS	When core to cladding concentricity is high, surface tension pulls the claddings into alignment and misaligns the cores, having an effect on splice losses. The splicer automatically performs an axis shift prior to arc fusion to minimize the effect. (Select ON⇔OFF)	✓	-	✓	✓
NanoTune	Automatically optimizes splice condition. (Select ON⇔OFF)	✓	-	✓	✓
NanoTune Threshold	Sets the NanoTune active level.	✓	-	✓	✓
Splice Method	Sets the splicing process to Automatic or Manual.	✓	-	✓	✓
MFD Mismatch Coef.	Sets the coefficient for an estimated loss yielded due to MFD mismatch.	-	-	✓	✓
Wavelength	Sets the wavelength for loss estimation calculation.	✓	-	✓	✓
MFD-L	Sets the MFD of left side optical fiber.	✓	-	✓	✓
MFD-R	Sets the MFD of right side optical fiber.	✓	-	✓	✓
Est. Loss Coef.	Sets the coefficient for loss estimation.	-	-	✓	✓
Minimum Loss	Sets the value to be added to an estimated loss.	-	-	✓	✓
Est. Loss Limit	Sets the threshold of estimated loss. If a reading exceeds the threshold, the splicer will give an error.	✓	-	✓	✓
Rearc Time	Sets the time for additional arc to be conducted after splicing.	✓	-	✓	✓
Estimation Mode	Sets the loss estimation method to "High(HDCM)" or "Standard". If "High" is chosen, the splicer will observe and inspect the core of spliced fiber with very high precision after fusion splicing.	✓	-	✓	✓
Rearc Power	Sets the output power of additional arc.	-	-	✓	✓
Proof Test	Enables or disables the proof test to be performed after splicing. If disabled, the proof test is not performed by pressing the SET icon or key and opening the hood.	-	-	✓	✓
Bubble check	Enables or disables the function of bubble check for spliced fiber.	✓	-	✓	✓

4. Splice program

<Arc discharging and motor driving systems during the splicing process>

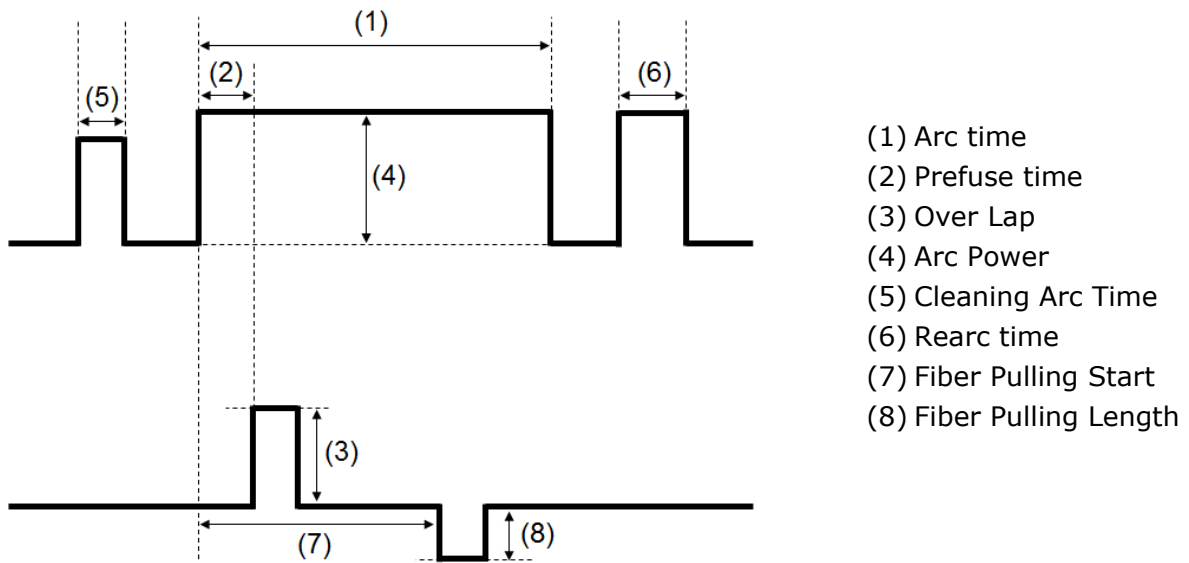

*(6) (7) (8) can only be edited in Administrator mode.

4. Splice program

NanoTune™ splice mode

The NanoTune™ analyzes a fiber end face and automatically fine-tunes splice program to achieve an ideal splice. When the NanoTune™ is activated, a dedicated splice screen appears.

Coping with poorly cleaved optical fiber, which cannot be spliced by conventional splicers, the NanoTune™ can yield the best quality and low loss splices.



1: Select NanoTune™ splicing program. Tap the Set icon(→).



2: Inspection of fiber end face. The NanoTune™ is activated when the end face is poor.

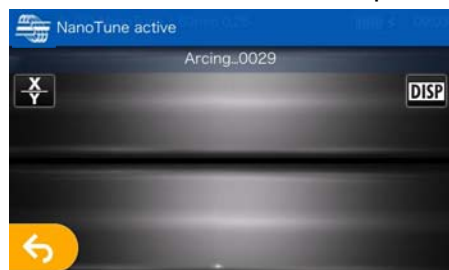

3: Arc is generated.

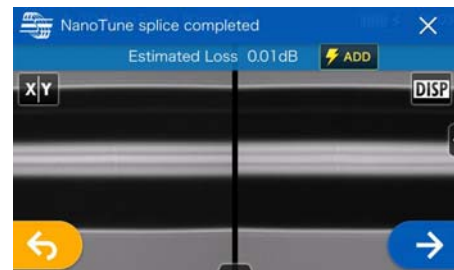

4: The NanoTune™ splice is completed and an estimated loss is displayed.



5: The proof test is started.

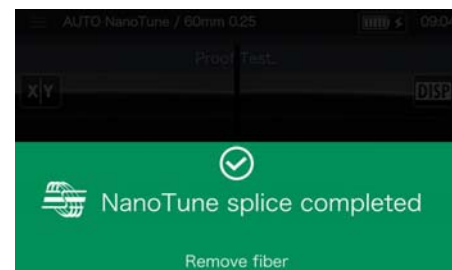

6: The proof test is complete.

The splicer stores data on representative fiber end shapes, and based on the data the NanoTune™ automatically fine-tunes splice condition to achieve an ideal splice. However, it does not provide a stable splice depending on the operational environments or conditions. In this case choose a suitable splice program by yourself.

4. Splice program

Attenuation splice mode

Attenuation splice mode creates an intentional core axial offset and splices fibers.



1: Tap the Splice program label once. Select the category of SMF G652.



3: Select "Target Loss" or "Fiber Core Offset for ATTN" to edit the value.



2: Select SM ATTN1 program. Tap the Pencil icon to edit the splice program.



4: Enter the value by touching the number keys, and then tap "Done" ().

An estimated splice loss displayed in the splicer varies depending on the fiber type being spliced and usage environment, and may not match an actual splice loss. It is recommended that actual splice losses be measured and checked with a power meter.

If the actual splice loss measured does not match the target splice loss, proceed to Step 5~6 of next page to make adjustments.

4. Splice program



5: Select "ATTN Coef." to edit the value.



6: Enter the value of ATTN Coef.
If the value is increased, fiber offset will become large and a splice loss will be higher. If the value is decreased, a splice loss will be lower.

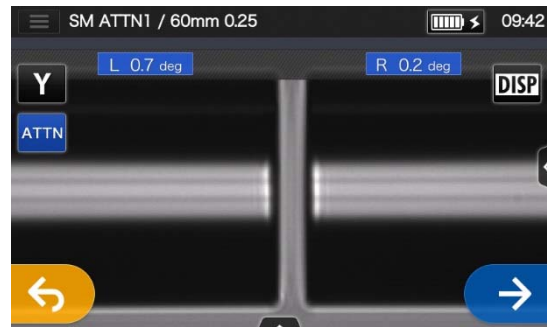

7: Tap Set icon () icon to perform a splice.

Check an actual splice loss. If the actual splice loss still does not match the target splice loss, go back to step 5~6 to adjust ATTN Coef again.

* Touch the ATTN icon on the arc pause screen to go to the setting screen.

Item	Details	Operator		Administrator	
		View	Edit	View	Edit
Target Loss	Sets the target splice loss for attenuation.	✓	-	✓	✓
Fiber Core Offset for ATTN	Sets the target core offset value for attenuation. This parameter will be changed in association with "Target loss".	✓	-	✓	✓
ATTN Coef.	This parameter is the attenuation splice coefficient. If actual splice loss measured does not match "Target Loss", this parameter can be used to adjust.	✓	-	✓	✓

5. Heater program

Heater program list

This product has heater programs pre-installed as a template. The programs are optimized according to the protection sleeve types. (▶P.2-10 Selecting heater program)

Category	Heater program	Details
Recent	—	The heater program selected recently is listed.
60mm	60mm 0.25	Can be used for heat shrinking 60mm protection sleeves for single fiber with 0.25mm coating, for example, Sumitomo FPS-1.
	60mm 0.25 Quick	Can be used for heat shrinking 60mm protection sleeves for single fiber with 0.25mm coating, for example, Sumitomo FPS-1. Select the program if you would like to reduce the heating cycle time. On the program, the heater is automatically heated up to the pre-heating temperature when the fusion splicing process is finished.
	60mm 0.25 ECO	Can be used for heat shrinking 60mm protection sleeves for single fiber with 0.25mm coating, for example, Sumitomo FPS-1. ECO mode is enabled and helps increase heat cycles per battery.
	60mm 0.9	Can be used for heat shrinking 60mm protection sleeves for single fiber with 0.9mm coating, for example, Sumitomo FPS-1.
40mm	40mm 0.25	Can be used for heat shrinking 40mm protection sleeves for single fiber with 0.25mm coating, for example, Sumitomo FPS-40.
	40mm 0.25 Quick	Can be used for heat shrinking 40mm protection sleeves for single fiber with 0.25mm coating, for example, Sumitomo FPS-40. Select the program if you would like to reduce the heating cycle time. On the program, the heater is automatically heated up to the pre-heating temperature when the fusion splicing process is finished.
	40mm 0.9	Can be used for heat shrinking 40mm protection sleeves for single fiber with 0.9mm coating, for example, Sumitomo FPS-40.
	40mm 0.4	Can be used for heat shrinking 40mm protection sleeves of Nano Sleeves N4 series, for example, Sumitomo FPS-N4-40.
Slim 60mm	S60mm 0.25	Can be used for heat shrinking 60mm semi-shrunk protection sleeves for single fiber, for example, Sumitomo FPS-61-2.6.
	S60mm 0.25 Quick	Can be used for heat shrinking 60mm semi-shrunk protection sleeves for single fiber, for example, Sumitomo FPS-61-2.6. Select the program if you would like to reduce the heating cycle time. On the program, the heater is automatically heated up to the pre-heating temperature when the fusion splicing process is finished.
	S60mm 0.25 ECO	Can be used for heat shrinking 60mm semi-shrunk protection sleeves for single fiber, for example, Sumitomo FPS-61-2.6. ECO mode is enabled and helps increase heat cycles per battery.
	S60mm0.25+5s	The program which heating duration is 5 sec. longer than "S60mm 0.25".
	S60mm0.25-5s	The program which heating duration is 5 sec. shorter than "S60mm 0.25".
Slim 40mm	S40mm 0.25	Can be used for heat shrinking 40mm semi-shrunk protection sleeves for single fiber, for example, Sumitomo FPS-40-2.6.
	S40mm 0.25 Quick	Can be used for heat shrinking 40mm semi-shrunk protection sleeves for single fiber, for example, Sumitomo FPS-40-2.6. Select the program if you would like to reduce the heating cycle time. On the program, the heater is automatically heated up to the pre-heating temperature when the fusion splicing process is finished.
	S40mm0.25+5s	The program which heating duration is 5 sec. longer than "S40mm 0.25".
	S40mm0.25-5s	The program which heating duration is 5 sec. shorter than "S40mm 0.25".

5. Heater program

Heater program list

The heating programs are optimized for Sumitomo protection sleeves. Select an appropriate heater program for the protection sleeve you are using.

Category	Heater program	Details
Drop	60mmDrop	Can be used for heat shrinking 60mm protection sleeves for drop cable splice, for example, Sumitomo FPS-D60.
	40mmDrop	Can be used for heat shrinking 40mm protection sleeves for drop cable splice.
Splice-On Connector	LYNX	Can be used for heat shrinking protection sleeves for 10mm cleaved Sumitomo's splice-on-connector "Lynx-CustomFit™".
	LYNX MINI	Can be used for heat shrinking protection sleeves for 5mm cleaved Sumitomo's splice-on-connector "Lynx-CustomFit™".
	E-SC Fusion	Can be used for heat shrinking dedicated protection sleeves for Sumitomo "E-SC Fusion Connector".
SPS	45mm Thin	Can be used for heat shrinking 45mm semi-shrunk protection sleeves for single fiber, for example, SPS-45.
	25mm 0.4	Can be used for heat shrinking 25mm protection sleeves of Nano Sleeves N4 series, for example, Sumitomo FPS-N4-25.
	25mm 0.9	Can be used for heat shrinking 25mm protection sleeves of Nano Sleeves N9 series, for example, Sumitomo FPS-N9-25.
	20mm 0.4	Can be used for heat shrinking 20mm protection sleeves of Nano Sleeves N4 series, for example, Sumitomo FPS-N4-20.
	20mm 0.9	Can be used for heat shrinking 20mm protection sleeves of Nano Sleeves N9 series, for example, Sumitomo FPS-N9-20.

■ Protection sleeves

The applicable fiber protection sleeves vary depending on the cleave length. Below are examples of protection sleeves.

Protection Sleeve	Sleeve Length [mm]	Diameter After shrink [mm]	Coating Diameter [mm]	Recommended Cleave length [mm]
FPS-1	60.5	Approx.3.2	0.25 to 0.9	16
FPS-40	40.5	Approx.3.2	0.25 to 0.9	10
FPS-61-2.6	61.5	Approx.2.6	0.25 to 0.9	16
FPS-D60	60.5	Approx.4.5×4.7	Drop/Indoor cable 2.0×3.1(or 2.6) /1.6×2.0	10

5. Heater program

Customizing heater program

Heater program can be customized as per your requirement by editing parameters set in the program.



1: On the "Heater Program screen" (▶P.2-10), Select the sleeve type where you would like to change the settings.



2: Tap the Pencil icon (✎) at the right upper corner of the screen.



3: Select the heater program you would like to edit.

An editable parameter has a > mark (➤) at the rightmost part of the row.



4: Select the parameter you would like to edit.



5: Delete the current value using ✕ icon first, and then edit the value and tap Done (Done).
*Std: is the default value.

Small pencil icon (✎) appearing at the upper right-hand corner of item names

In the above example, Heating Duration B is changed to 22 sec from the default 0 sec. After the default value of an item has been changed, a small pencil icon (✎) appears at the upper right-hand corner of the item name, enabling a user to understand that the Default value has been changed.



5. Heater program

Copying heater program (in Administrator mode)

In Administrator mode, you can create your own new heater program by copying an existing heater program to a blank area of heater programs. After the copy, you can edit the name of the copied program and change the parameter settings.

First, log in to Administrator mode to do this action.

(▶P.8-1 Logging in to and logging out of Administrator mode)



1: On the “Heater Program screen” (▶P.2-10), Select the sleeve type where you would like to change the settings.



Heater Program edit screen

2: Tap the Pencil icon (✎) at the right upper corner of the screen.

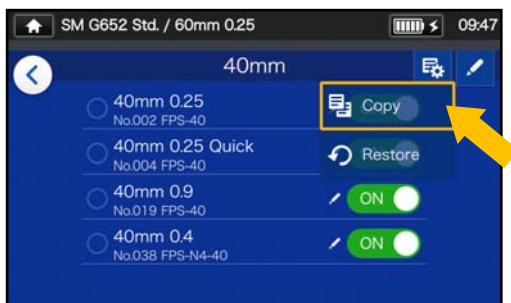

3: Tap (⚙️). A pull-down menu appears. Select Copy (📄 Copy) from the pull-down menu that appears.

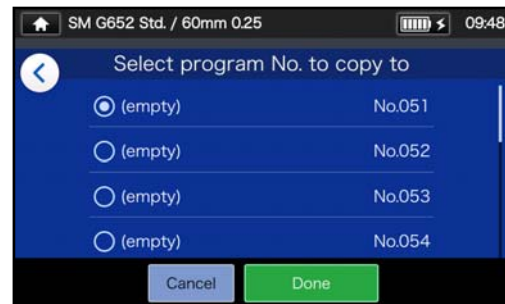

4: Select the program you want to copy and tap Done (Done).

Next, select where you want to paste the copied program and tap Done (Done).



5: You can edit the name of the copied program and change the parameter settings.

▶P.5-3 Customizing heater program

An editable parameter has a > mark (➤) at the right-most part of the row.

5. Heater program

Showing/Hiding heater program (in Administrator mode)

An administrator can show or hide heater programs in the Operator mode. First, log in to Administrator mode to do this action.

(►P.8-1 Logging in to and logging out of Administrator mode)



1: Referring to the procedures in Page 5-4, go to "Heater Program edit screen". Tap the Pencil icon () at the right upper corner of the screen.



3: After  is selected, the selected heater program will be hidden in the Operator mode.



2: Tap   to switch between ON⇌OFF.

►P.4-5 Showing/Hiding splice program



The heater program which is currently selected for use cannot be hidden. To hide the program, first select other program to deselect the program, and then do the above procedures.

Once heater program is displayed in the Operator mode, it is still saved after the power is switched off.

5. Heater program

Heater program editable items

Editable items	Details	Operator		Administrator	
		View	Edit	View	Edit
Name	Allows to edit the name of Heater program.	-	-	✓	✓
Abbreviated name	Allows to edit the name of Heater program which is displayed on the main screen.	✓	-	✓	✓
Sleeve	Allows to edit the name of protection sleeve.	-	-	✓	✓
Template	Views an original Heater program which was copied.	✓	-	✓	-
Note	Allows to add a note to the selected Heater program (up to 21 characters)	✓	✓	✓	✓
Preheating Temperature*	Temperature for the pre-heating duration of the heating cycle. (Numerical input)	✓*	✓*	✓*	✓*
Preheating Time*	Duration for maintaining the Pre-heating Temp. (Numerical input) *When the heating process is started, the pre-heating process is automatically finished.	✓*	✓*	✓*	✓*
Heat Up Temperature A	Heating element is heated up to the set temperature in the first half duration of the heating cycle. (Numerical input)	✓	✓	✓	✓
Heating Duration A	The first half duration of heating cycle. (Numerical input)	✓	✓	✓	✓
Heat Up Temperature B	Heating element is heated up to the set temperature in the latter half duration of the heating cycle. (Numerical input)	✓	✓	✓	✓
Heating Duration B	The latter half duration of the heating cycle. (Numerical input)	✓	✓	✓	✓
Finish Temperature	Temperature which cooling operation lowers to for completion of the entire heating process. (Numerical input)	✓	✓	✓	✓
Add Cooling Finish Temperature	Sets the temperature of finishing the additional cooling process.	✓	✓	✓	✓

*For Quick of heater program

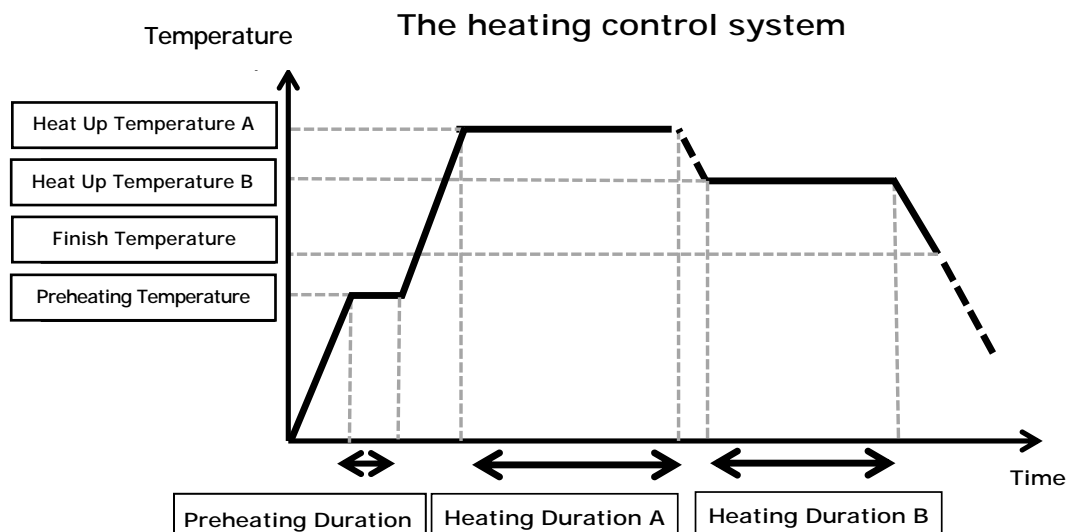

The heating control system is individually applied to each heater.

Menu screen

From Menu screen, you can access menu options to edit the settings. For more details, see the next pages.

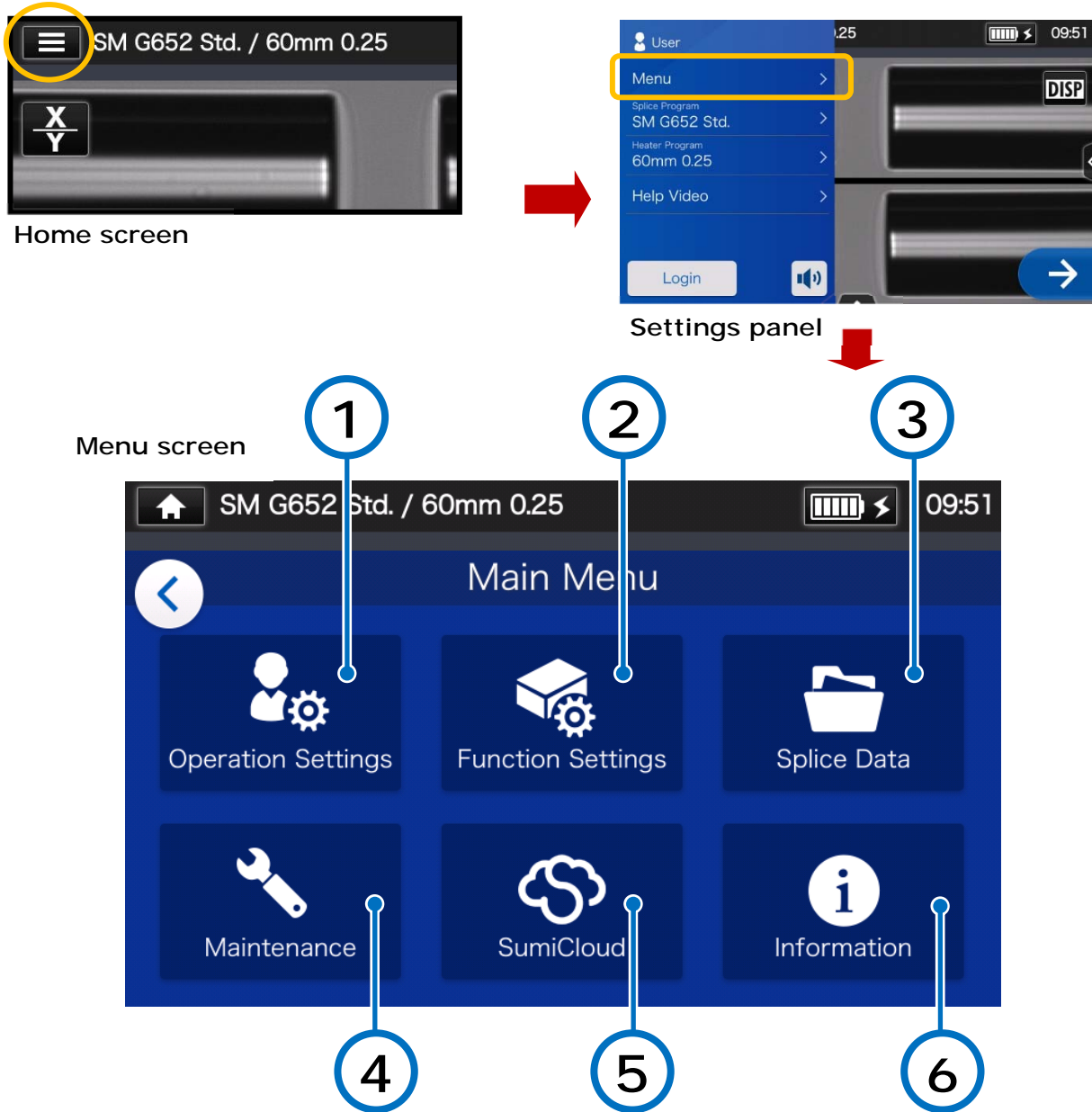

- ① Operation Settings : Edit the splicer operation settings such as auto start, re-arc, etc..... ▶P.6-2
- ② Function Settings: Edit the function settings such as language, sound, monitor brightness, etc..... ▶P.6-5
- ③ Splice Data: View splice data and edit data storage settings, etc ▶P.6-7
- ④ Maintenance: Edit the maintenance settings such as Conditioning arc, arc count reset, etc ▶P.6-9
- ⑤ SumiCloud™: Connect the splicer to your smartphone via wireless LAN network ▶P.6-10
- ⑥ Information: Displays the splicer information..... ▶P.6-12

Operation Settings

Edit Operation Settings



1: Tap the Settings panel icon (☰) to open the Settings panel.



2: Tap the Menu label (Menu) to display the Menu screen.

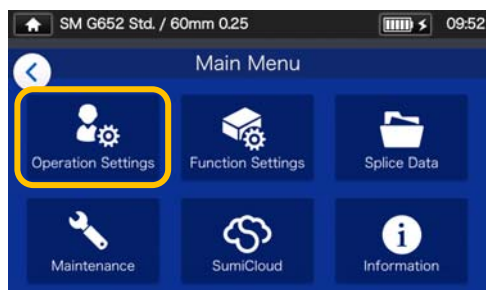

3: Tap "Operation Settings" icon (👤⚙️) on the Menu screen to edit the settings.

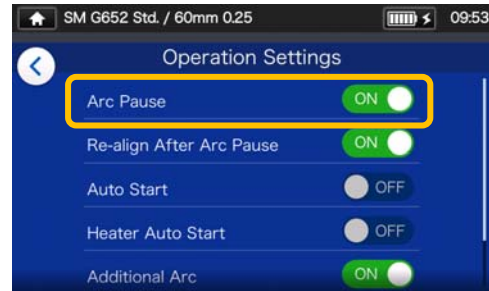

4: Tap to toggle an item ON or OFF as desired.

Scroll down the screen to view all the items.
 ▶ For the details of the items, see the next page.

■ Operation Settings details

Editable items	Details	Operator		Administrator	
		View	Edit	View	Edit
Arc Pause	Stops the splicing process temporarily before arcing. If you would like to check fiber offset and fiber end faces during the process, set this function to ON.	✓	✓	✓	✓
Re-align After Arc Pause	Fibers are aligned again prior to splicing after Arc Pause.	✓	✓	✓	✓
Auto Start	Automatically starts the splicing process when the fiber is inserted in the splicer and the hood is closed.	✓	✓	✓	✓
Heater Auto Start	Automatically starts the heating process when the fiber is placed into the heat shrink oven.	✓	✓	✓	✓
Add Arc	Additional arc is available by setting this function to ON. If an arc is insufficient, an additional arc should be performed.	✓	✓	✓	✓
Add Arc Settings	Allows to adjust the arc power for additional arc.	✓	✓	✓	✓
Ignore Cleave Angle Limit	If this item is set to ON, the splicer will ignore a result of cleave angle inspection. The default is OFF.	-	-	✓	✓
Ignore Cleave Errors	If this item is set to ON, the splicer will ignore a result of cleaving quality inspection. The default is OFF.	-	-	✓	✓
Fiber Insertion Screen	Single (X or Y) screen type or dual (X above Y, X beside Y) screen type can be selected in each step of the splicing process.→ For more information, refer to the next page.	-	-	✓	✓
Pre-Fusion Screen		-	-	✓	✓
Arc Screen		-	-	✓	✓
Post-Fusion Screen		-	-	✓	✓
Est. Loss Screen		-	-	✓	✓
Postsplice Action (Proof-Reset)	Allows to select an action to be done after splicing, i.e. a proof test is carried out or not, and reset action is automatically performed or not.	-	-	✓	✓

A pass code is required to log in to Administrator mode. ▶P.8-1.

6. Functions

■ Splicing process screen setup (Available in Administrator mode)

Log in to Administrator mode. From the Operation Settings, you can choose a view of the fibers for the 5 stages of the splicing process.

- Fiber Insertion Screen
- Pre-Fusion Screen
- Arc Screen
- Post-Fusion Screen
- Est. Loss Screen

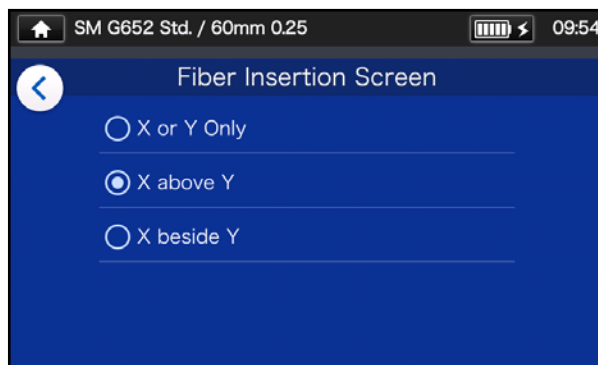
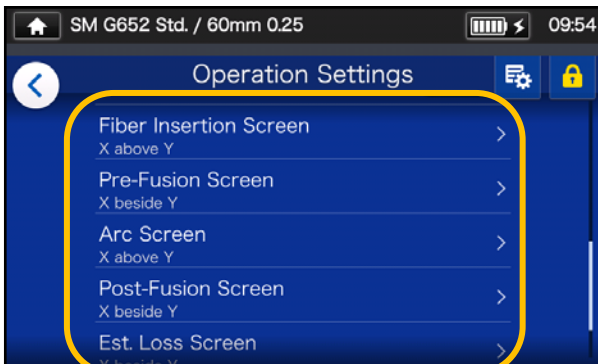
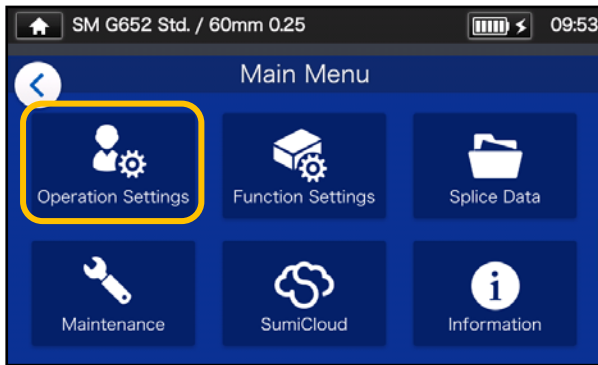

X or Y only

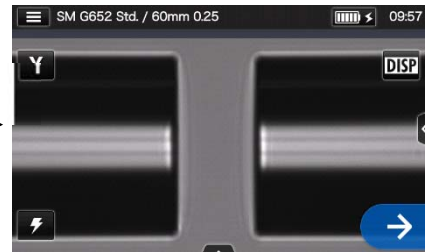

If "X or Y only" is selected, X or Y screen is displayed on the screen.

X above Y

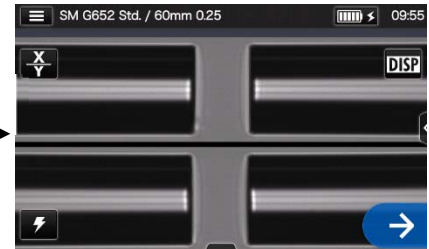

If "X above Y" is selected, X and Y screens are vertically displayed on the screen.

X beside Y

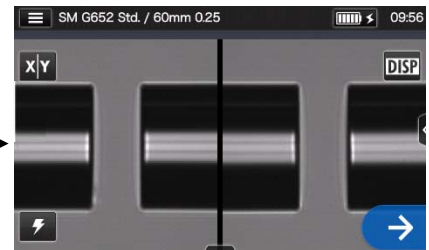

If "X beside Y" is selected, X and Y screens are horizontally displayed on the screen.

Function Settings

Edit Function Settings



1: Tap the Settings panel icon (☰) to open the Settings panel.

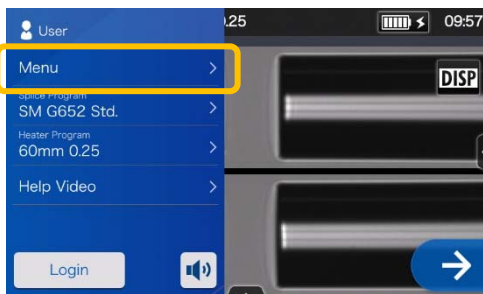

2: Tap the Menu label (Menu) to display the Menu screen.

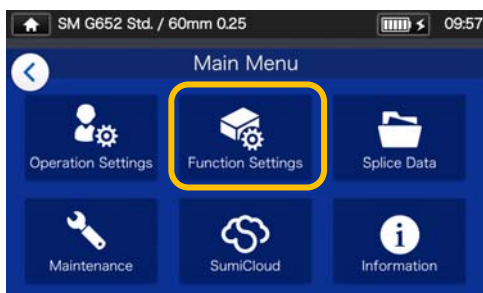

3: Tap "Function Settings" icon (⚙️) to edit the settings.



4: Tap the item you would like to edit.

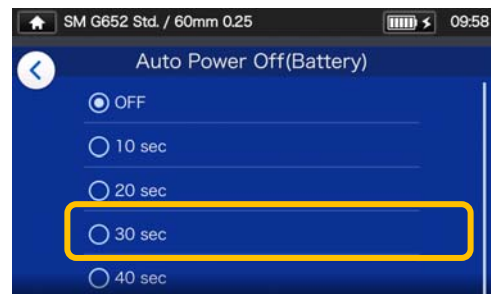

5: Edit the setting as desired.

Scroll down the screen to view all the items.
►For the details of the items, see the next page.

■ Function Settings details

Editable items	Details	Operator		Administrator	
		View	Edit	View	Edit
ECO Mode	Saves power consumption by adjusting monitor brightness and heat shrink oven temperature.	✓	✓	✓	✓
Sleep(Battery)	If the splicer is not interrupted on battery operation for a certain period of time, to minimize power consumption, it will go into Sleep mode and the monitor will be turned off. Press any keys except the power key to re-start the splicer.	✓	✓	✓	✓
Auto Power Off (Battery)	If the splicer is in Sleep mode and not interrupted on battery operation for another certain period of time, it will automatically switch off. Switch it back on again.	✓	✓	✓	✓
Sleep(AC)	If the splicer is not interrupted on AC operation for a certain period of time, to minimize power consumption, it will go into Sleep mode and the monitor will be turned off. Press any keys except the power key to re-start the splicer.	✓	✓	✓	✓
Auto Power Off(AC)	If the splicer is in Sleep mode and not interrupted on AC operation for another certain period of time, it will automatically switch off. Switch it back on again.	✓	✓	✓	✓
Screen Brightness	The brightness of the monitor can be adjusted by seven stages.	✓	✓	✓	✓
Date (yyyy/mm/dd hh:mm)	Sets the built-in clock to a local time.	✓	✓	✓	✓
Language	Display language can be selected.	✓	✓	✓	✓
Temperature Unit	This function switches the temperature units.	✓	✓	✓	✓
Sound	Turn on or off the touch sound.	✓	✓	✓	✓
Volume	Adjust the touch sound volume.	✓	✓	✓	✓
Sound Settings	Allows to edit Error Sound/Splice Sound/Heat Sound/Shutter Sound/Startup Sound settings.	✓	✓	✓	✓
Light for v-groove	This function sets the V-groove illumination to ON or OFF.	✓	✓	✓	✓
Screen Rotation	Screen rotation can be selected from either front or rear.	✓	✓	✓	✓
Opening Title1	Allows to create a text to be displayed on a splicer startup screen. Max number of characters: 21	-	-	✓	✓
Opening Title2		-	-	✓	✓

A pass code is required to log in to Administrator mode.▶P.8-1.

Splice Data

Edit Splice Data settings



1: Tap the Menu label (Menu) on the Settings panel to display the Menu screen.

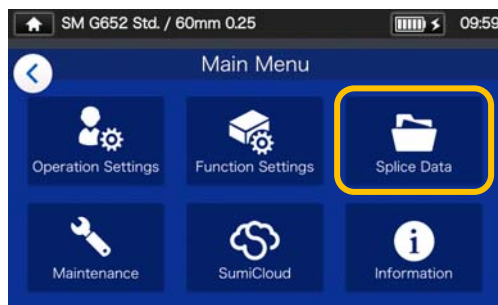

2: Tap "Splice Data" icon (Splice Data icon) to edit the settings.

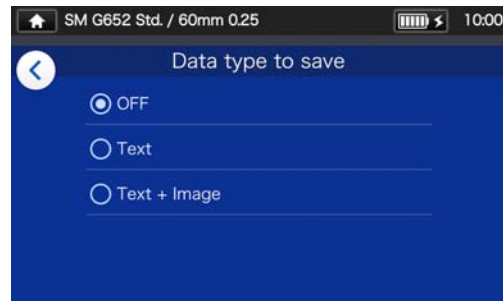
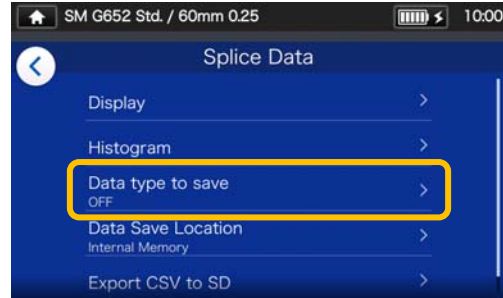

3: Tap the item you would like to edit or carry out.

Splice Data details

Editable items	Details	Operator		Administrator	
		View	Edit	View	Edit
Display	Displays stored splice data. (Internal memory or SD card)	✓	✓	✓	✓
Histogram	Displays a histogram of "Splice losses" and "cleave angles" based on stored splice data.	✓	✓	✓	✓
Data type to Save	Allows to select data type to store from "Text + Image", "Text" and "OFF".	✓	✓	✓	✓
Data Save Location	Allows to select a location to save the data. (Internal memory or SD card)	✓	✓	✓	✓
Export CSV to SD	Converts splice data stored in the internal memory or a SD card into a CSV format and save the CSV file in the SD card.	✓	✓	✓	✓

View splice data

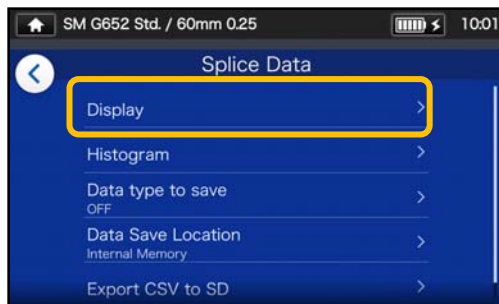

1: From the Splice Data screen (see the previous page) select "Stored Splice Data" and select a data storage location.



2: Select a data point from the splice dates/times.



3: You can view the details of the splice data point you selected.

<Splice data details summary>

- Fiber Offset Inspected offset of the core axis (or diameter axis).
- Core Offset Inspected core step status of the offset caused by deformation
- Core Angle Inspected tilt angle of the core axis caused by deformation.
- Concentricity Inspected core eccentricity of the (L/R) fiber.
- Cleave Angle Inspected cleave angle of the (L/R) fiber.
- Image Captured fiber image
- Memo A short note can be entered.

In Administrator mode, the details of splice program setup items can be viewed.

For more information, please refer to P.4-6 and P.4-7.

Search for splice data

Tap the magnifying glass icon (🔍) to search for a splice data point. You will be moved to the search screen where you can search within a range of splice dates.

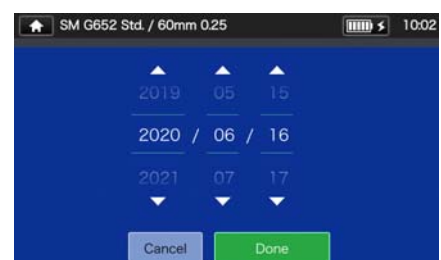

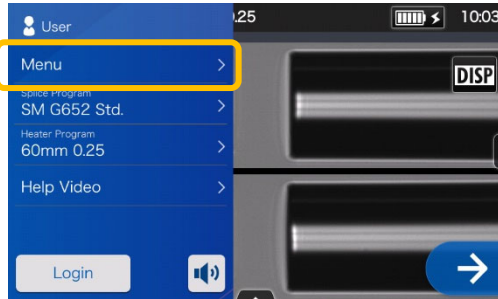

Maintenance

Edit Maintenance settings

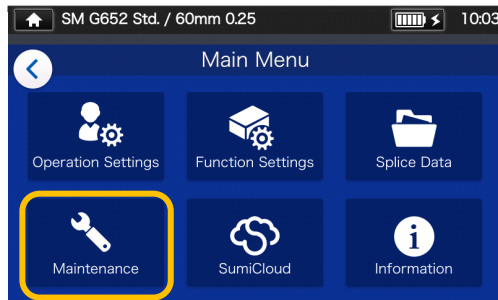

1: Tap the Menu label (**Menu**) on the Settings panel to display the Menu screen.



2: Tap "Maintenance" icon () to edit the settings.

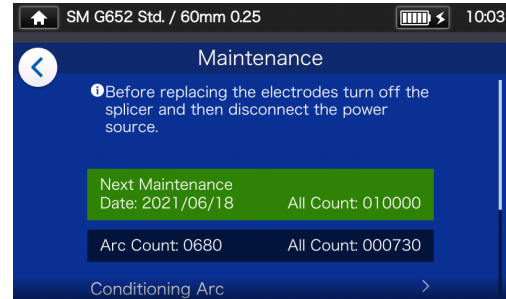

3: Tap the item you would like to edit or carry out.

Once the next maintenance date or total arc count which is set by service center has been reached, the splicer shows a maintenance reminder dialog once a day.

A pass code is required to log in to Administrator mode. ▶P.8-1.

Maintenance details

Editable items	Details	Operator		Administrator	
		View	Edit	View	Edit
Arc Count	Views arc count. *It can be reset on "Reset Arc Count" option.	✓	-	✓	-
All Count	Views Total arc count counted since shipment from the factory.	✓	-	✓	-
Conditioning Arc	After electrodes are replaced, this function is used to condition new electrodes. The number of times of conditioning arc is preset. Arc Count is automatically reset after conditioning arc is performed.	✓	✓	✓	✓
Self Inspection	The circuit board, optical unit, motors and heat shrink oven are automatically inspected.	✓	✓	✓	✓
Motor Calibration	The condition of all motors is inspected.	-	-	✓	✓
Caution for Arc Count	Sets an arc count at which a caution for electrode replacement is displayed. ▶P.3-5 Electrode replacement	✓	-	✓	✓
Warning for Arc Count	Sets an arc count at which a warning for electrode replacement is displayed. ▶P.3-5 Electrode replacement	✓	-	✓	✓
Reset Arc Count	Allows to reset the arc count. *All Count cannot be reset.	-	-	✓	✓
Restore Data	All parameters except Arc Count and All Count are returned to the factory settings.	-	-	✓	✓

SumiCloud™

The TYPE-Q102-CA+ can connect to a smartphone via wireless LAN using a dedicated wireless LAN SD card (WLSD series) and can be operated with the smartphone. To establish the connection, smartphone application "SumiCloud™" is required. Download and install it from "Google Play" or "Apple" online store.

In "SumiCloud™", you can utilize various functions as shown in the table in the next page.

1: Insert the wireless LAN SD card into the splicer. SD card icon appears on the top of the screen.

2: Tap the SumiCloud™ icon to edit the settings.

3: Set "Smartphone Connection" to "ON" to enable wireless LAN connection to connect the splicer to a smartphone via wireless LAN. When wireless LAN connection becomes available, wireless LAN icon () appears on the monitor screen.

4: Start your smartphone and enter the password to enable wireless LAN connection.

Factory default password is "12345678".

5: Start "SumiCloud™" on the smartphone.

*If the wireless LAN SD card is not inserted in the splicer, the function cannot be enabled.

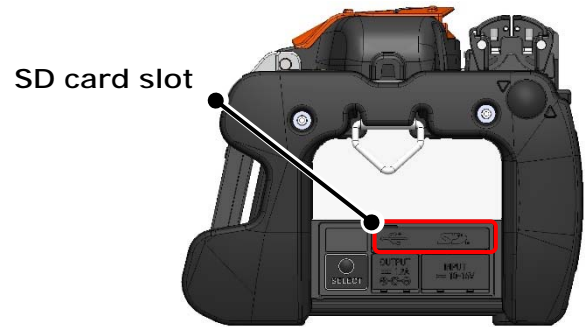

- **Network SSID:** is the name that devices can identify an inserted SD card as.
- **Password setting:** is required to connect the splicer to devices. Choose this option to change a password. The password must be 8-20 alphanumeric characters long. To validate a new password, re-boot the splicer.

6. Functions

■ SumiCloud™ function

* For further information, refer to the operation manual of SumiCloud™ and SumiCloud™ server.

Function	Details
Preventive maintenance	<ul style="list-style-type: none">-The SumiCloud™ app notifies users of the deterioration of parts such as a cleaver.-Displays two levels of alerts, "Caution" and "Warning".-A list of preventive maintenance status can be viewed on SumiCloud™ server.
Splice Data Management	<ul style="list-style-type: none">- View splice data on smartphone screen- Cloud data server available for storage of all splice data- Splice data with GPS location
Report Builder	<ul style="list-style-type: none">- Automatically creates splicing report and sends by e-mail- Add splice location on the GPS map to the report
Help Video	<ul style="list-style-type: none">- Visual tutorial for splice operation on smartphone- Help video for related products available
Software update	<ul style="list-style-type: none">- Automatic update via smartphone- Keep splicer up to date for comfortable daily operation
Health Scan	<ul style="list-style-type: none">-Health Scan is the function that performs simple inspection and diagnosis on a fusion splicer.-When the result is unacceptable, the SumiCloud™ app shows troubleshooting (such as what to clean) to users.-Displays a link to help videos for troubleshooting.

Other than the above functions, some more functions and service are available.

Information

You can view the splicer-related information in the Information screen.

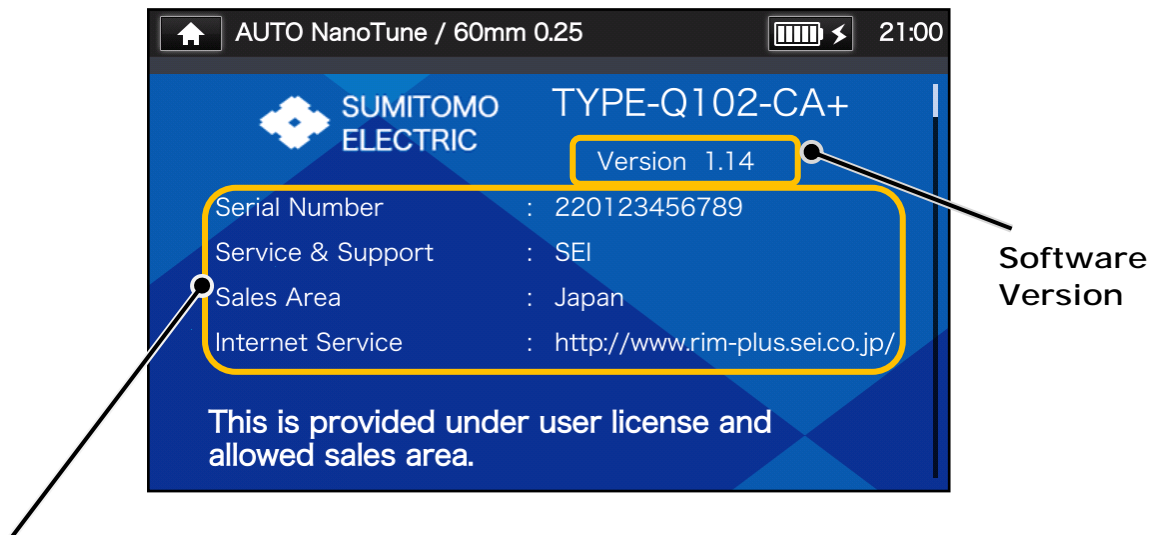

Serial Number: Is required for maintenance of the splicer.

Service & Support: Shows the name of the company that handles sales and maintenance.

Sales Area: Shows the area where this product is sold.

Internet Service: Shows the internet address where the splicer software is updated.



Scroll down the page to view all the patent information.

7. Other convenient functions

The TYPE-Q102-CA+ incorporates various functions. Set up and utilize the functions as necessary.

Back monitor type

The screen display rotates upside down automatically when the monitor is set to the back monitor type by flipping it up. The back monitor type is convenient when you would like to place fiber close to you.

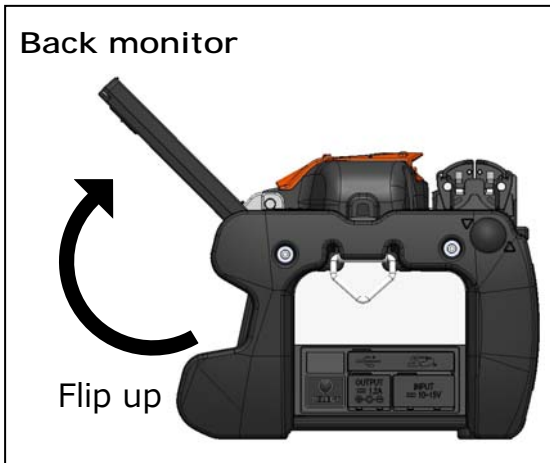

Operating direction



When the monitor is in the back position, your splicing work is easier if the right-hand and left-hand coating clamps are swapped. Refer to the following procedures.

- 1: Loosen the coating clamp fixing screw to remove the coating clamp.

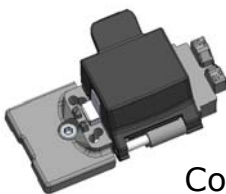

Coating clamp

- 2: After swapping the right-hand and left-hand coating clamps, tighten the coating clamp fixing screw. The lid of the coating clamp is opened in the same direction as the front monitor type.

Coating clamp fixing screw

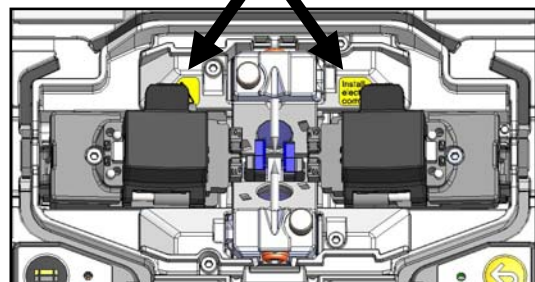
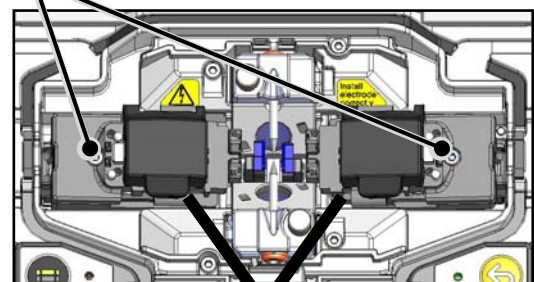

7. Other convenient functions

Universal clamp

The TYPE-Q102-CA+ can work with both tight buffer and loose buffer coatings as a standard specification. Set the position of the lid of the coating clamp according to the fiber coating type.

- 1: Loosen the coating clamp fixing screw to remove the coating clamp.

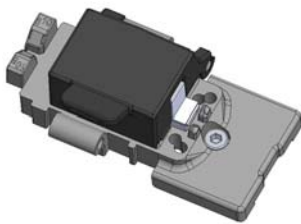

Coating clamp

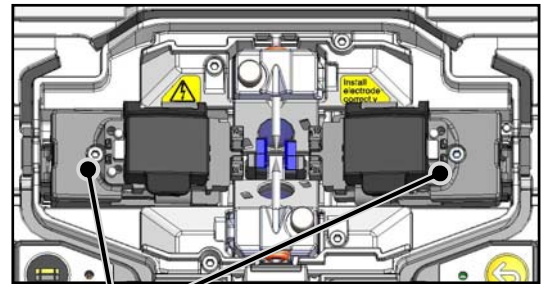

Coating clamp fixing screw

- 2: Open the lid of the coating clamp by 180°. The lid can be moved back and forth. Set the position of the lid according to the fiber coating type, and then close the lid.

*Prepare the loose buffer fiber as below.

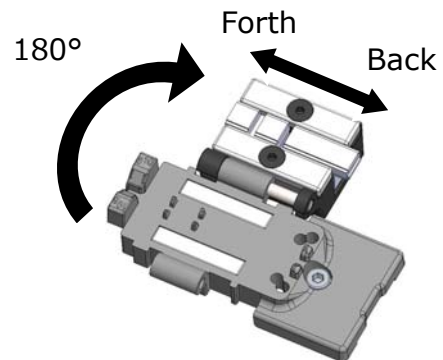
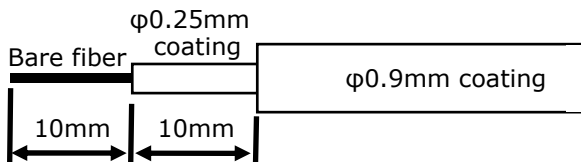

>>Tight buffer : back
>>Loose buffer : forth

- 3: Re-fit the coating clamp back to the splicer.

<Applicable cleave length for the universal clamp>

Position of the lid	Type of fiber coating	Diameter of fiber coating [μm]	Applicable cleave length [mm]
Back	Tight buffer	Up to 250	5 to 16
		Over 250	8 to 16
	Loose buffer	-	NOT applicable
Forth	Tight buffer	Up to 250	5 to 10
		Over 250	8 to 10
	Loose buffer	250 primary/ 900 secondary	10 (Refer to the figure above)

7. Other convenient functions

Fiber holder operation

You can use fiber holders for single fiber to splice fibers by removing the coating clamp. Sumitomo FHS series fiber holders are applicable.

- 1: Loosen the coating clamp fixing screw to remove the coating clamp.

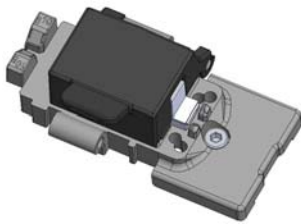

Coating clamp

- 2: There is a holder stage under the coating clamp. A fiber holder can be placed on the holder stage.

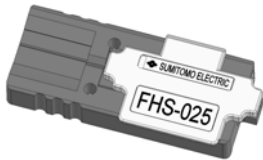

Fiber holder
FHS-025

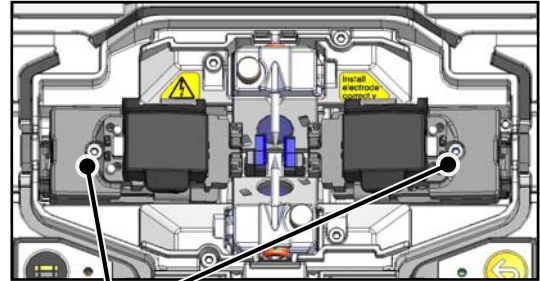

Coating clamp fixing screw

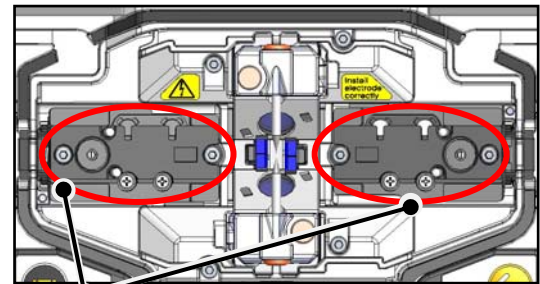

Holder stage

Fiber holder operation with the back monitor type

When the fiber holder is used with the monitor in the back position, your splicing work is easier if the direction of opening of the fiber holder lid is changed. Refer to the following procedures.

- 1: Loosen the holder stage fixing screw to remove the holder stage.

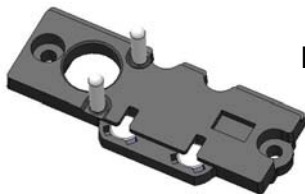

Holder stage

- 2: After swapping the right-hand and left-hand holder stages, tighten the holder stage fixing screw. The lid of the fiber holder is opened in the same direction as the front monitor type.

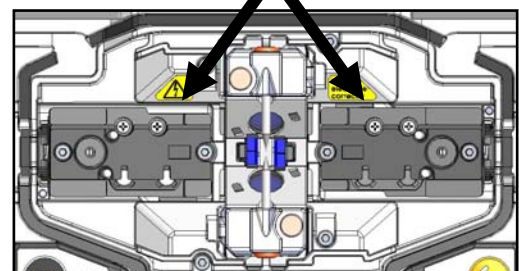
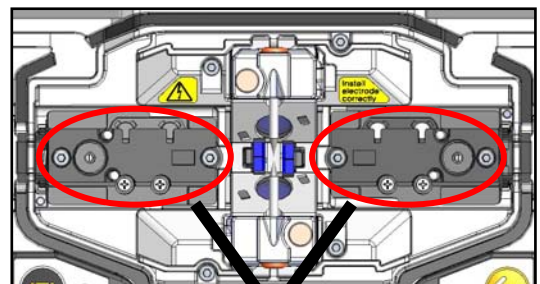

7. Other convenient functions

Detachable/attachable bare fiber pads

The bare fiber pad is attached to the hood and they are moved together when the hood is opened and closed. The bare fiber pad is detached from the hood to make sure if the fiber is clamped properly.

The clamping condition can be corrected by re-positioning the clamps one by one.

How to use

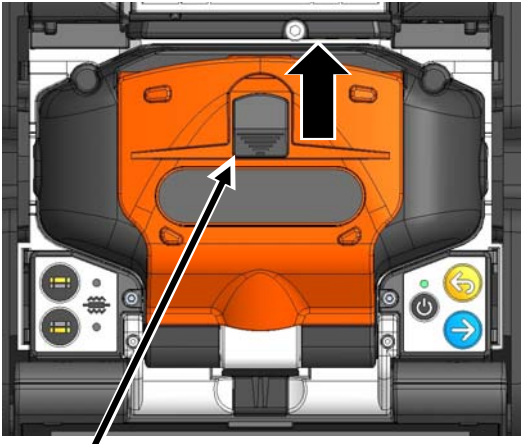
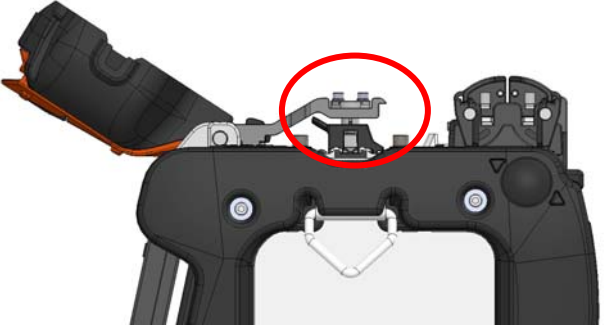
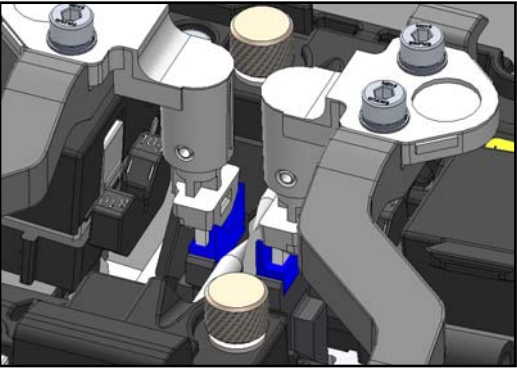
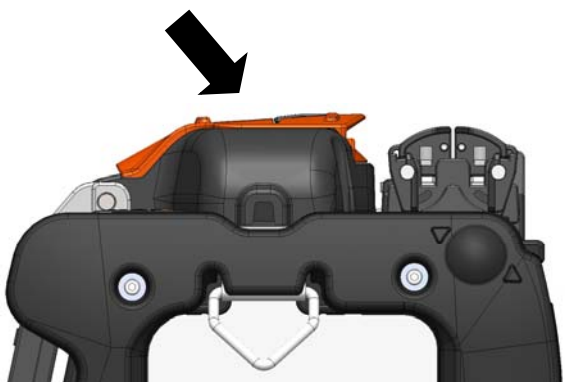
<p>1.</p>  <p>Bare fiber pad release button</p>	<p>2.</p> 
<p>Slide the bare fiber pad release button in the direction indicated by the arrow.</p>	<p>When the hood is opened, the bare fiber pad is detached from the hood.</p>
<p>3.</p> 	<p>4.</p> 
<p>Make sure the bare fiber pad clamps the fiber properly.</p>	<p>When the hood is closed, it catches the bare fiber pad. The hood and fiber pads are moved together.</p>

7. Other convenient functions

Heater clamp operation

The heater lid can be separated from, or linked with the heater clamp by setting the lever of the heater clamp to the left or right.

Heater clamp lever

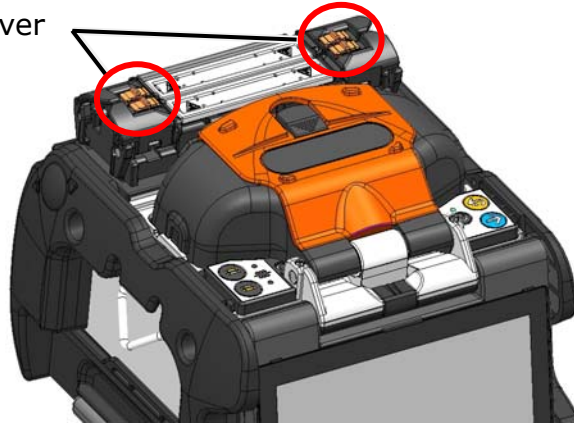

How to use

<p>1.</p>	<p>2.</p>
<p>Slide the heater clamp lever in the direction indicated by the arrow. *The example shows the right-hand lever is moved.</p>	<p>The heater clamp lid and heater lid move independently.</p>
<p>3.</p> <p>40mm protection sleeve</p> <p>Protection sleeve</p>	<p>4.</p>
<p>The position of the protection sleeve can be manually adjusted when the heater lid and heater clamp move independently. *The example shows 40mm sleeve is placed in the heater.</p>	<p>The heater clamp lid and heater lid move together by sliding the lever in the direction indicated by the arrow.</p>

7. Other convenient functions

Auto start

The TYPE-Q102-CA+ has Auto start function that automatically starts the splicing process and the heating operation.

Auto start splicing

When fiber is inserted into the splicer and the hood is closed, the splicing process is automatically started. No need to press Set key (→) or touch Set icon (→).

Auto start heating

When fiber is placed into the heat shrink oven, the heater lid is automatically closed, and then the heating operation is automatically started. No need to press Heater key (⊞) or touch Heater icon (⊞).

Tripod fixing screws

The TYPE-Q102-CA+ has screw holes for M8 screw and 1/4-20UNC screw on its bottom.

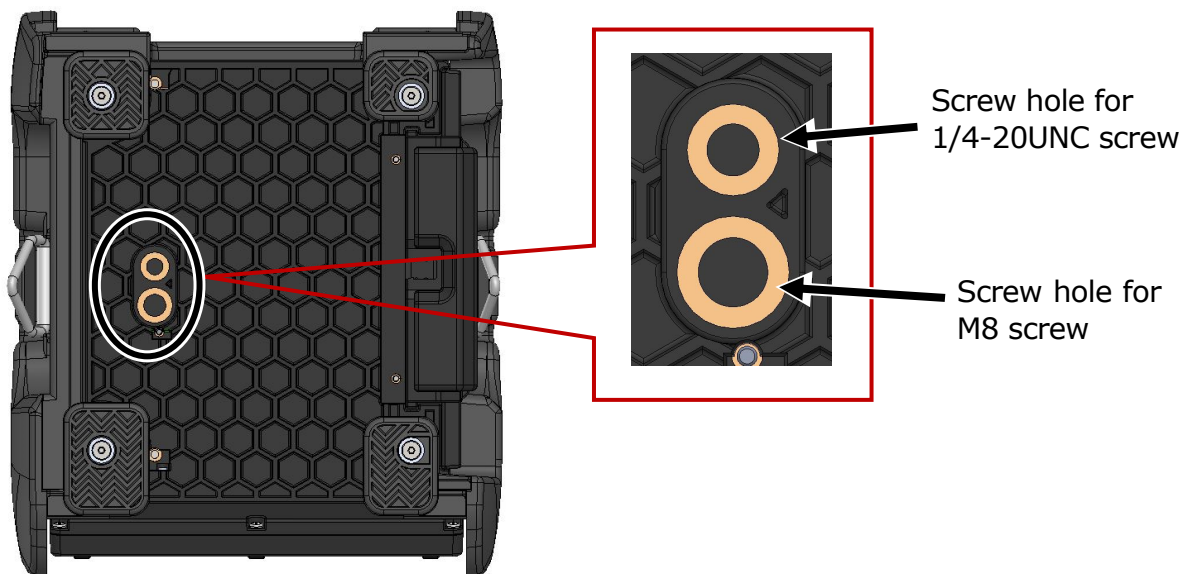

Caution

- In a high location, secure the TYPE-Q102-CA+ to a tripod with M8 screw or 1/4-20UNC screw on its bottom to prevent it from dropping.
- Do not use a tripod with a thread length of >13mm (33/64"). Doing so can risk damage the fusion splicer.

7. Other convenient functions

Hand strap

The hand strap is supplied with the TYPE-Q102-CA+. Secure it to the splicer referring to the following procedures.

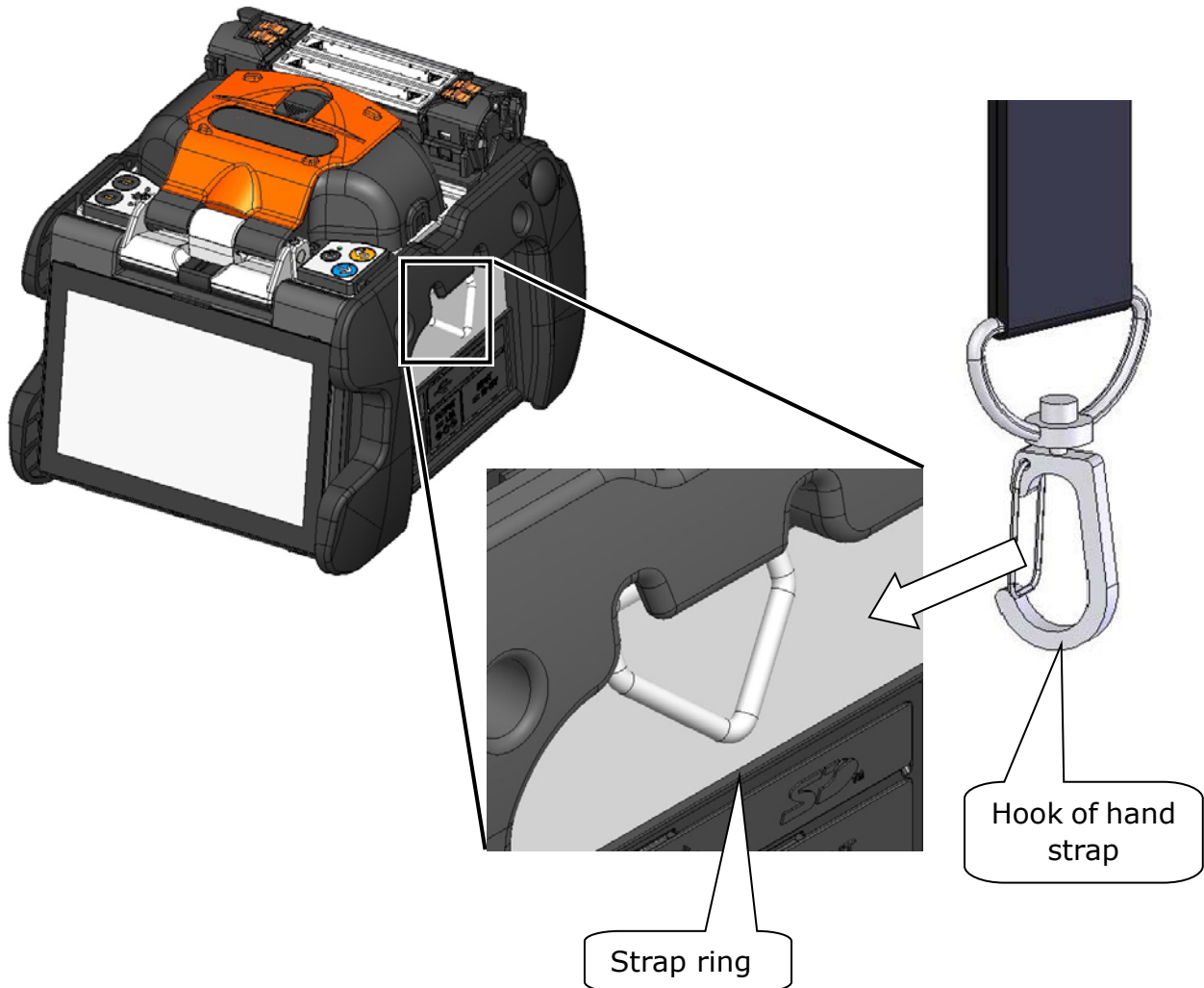

Please hook the end of the hand strap to the strap ring on the right and left sides of the TYPE-Q102-CA+.



If the hand strap is not hooked to the strap ring properly, the TYPE-Q102-CA+ can be dropped.

8. Administrator mode

An administrator can edit splice/heater program parameters and function settings which are not visible in Operator mode. The administrator can also setup a password to keep operators from accessing functions.

The default password for Administrator mode is '0000'.

- ▶ P.8-2 Changing Administrator password

Logging in to and logging out of Administrator mode

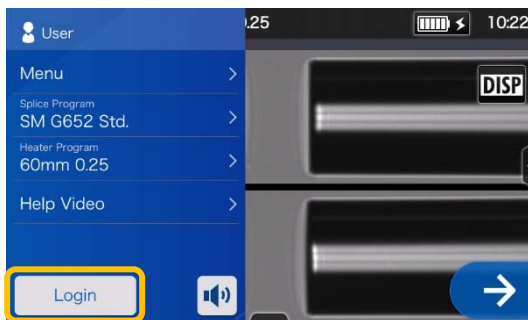

1: Open the Settings panel. Tap "Login".



3: After the entered password is verified, "Administrator" label is displayed on the Settings panel. You are in Administrator mode.



2: Enter the default password '0000', and tap "Done" (Done).

Logging out

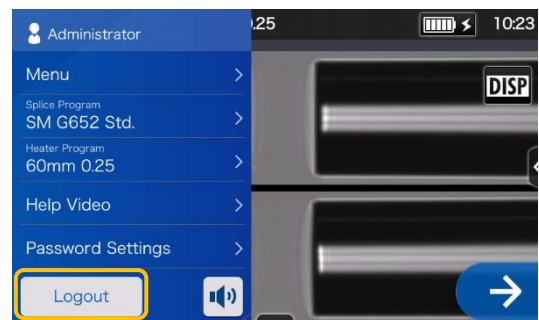

Tap "Logout" on the setup panel to log out of Administrator mode. After logging out, you'll be brought back to Operator mode.



Once you enter the password, you will remain logged in until you turn off the power.

8. Administrator mode

Changing Administrator password

The login password can be changed in Administrator mode. Log in to Administrator mode referring to Page 8-1, and then follow the procedures below.

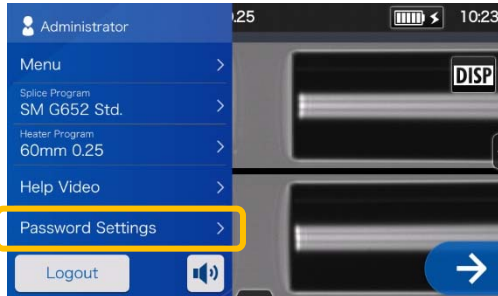

1: Open the Administrator settings panel. Tap "Password Settings".



2: Tap "Change Password".

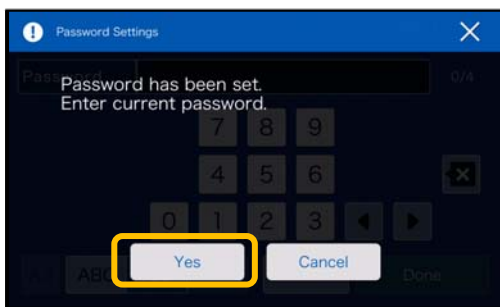

3: Enter the current 4-digit password and tap "Done" (Done).

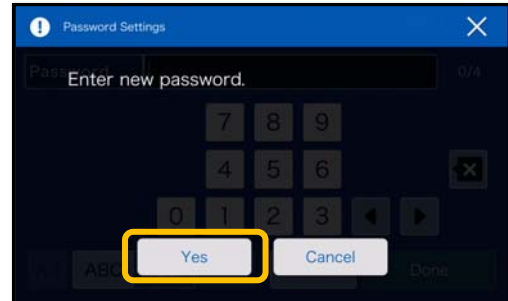

4: Enter a new 4-digit password, and then tap "Done" (Done). Confirm the new password, and then tap "Done" (Done).



5: The password is changed.

If you've forgot the Administrator password, you cannot access Administrator mode. In this case please contact our maintenance service center.

8. Administrator mode

Lock functions

Startup password protection

The security setting requires an operator to enter a password upon startup of the TYPE-Q102-CA+ on a specified date.



1: Open the Administrator settings panel. Tap "Password Settings".

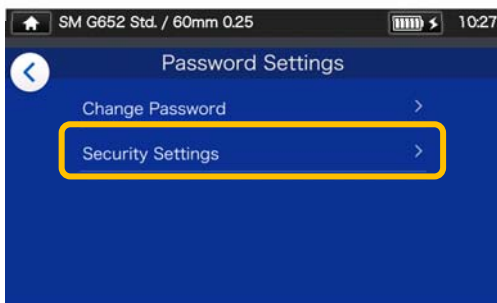

2: Tap "Security Settings". On the next screen, tap OFF (OFF) in "Security".

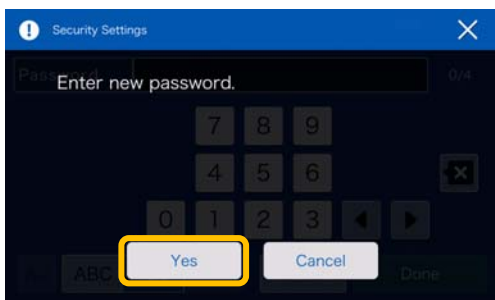

3: You'll be directed to the startup password setup screen.



4: Enter a min.4 to max.16 digit startup password, and then tap "Done" (Done).

Reenter the password for confirmation, and then tap "Done" (Done).

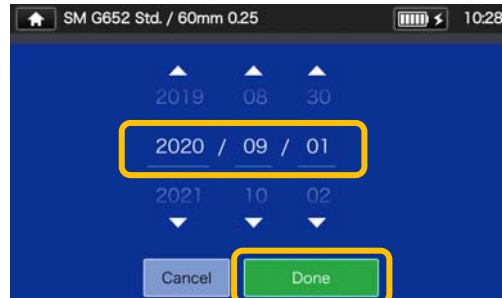

5: Enter a date when the splicer will request a password entry. Change the dates using ▼▲ icons, and then tap "Done" (Done). Past dates cannot be set.



6: Security setting is enabled.

8. Administrator mode

Security Settings screen

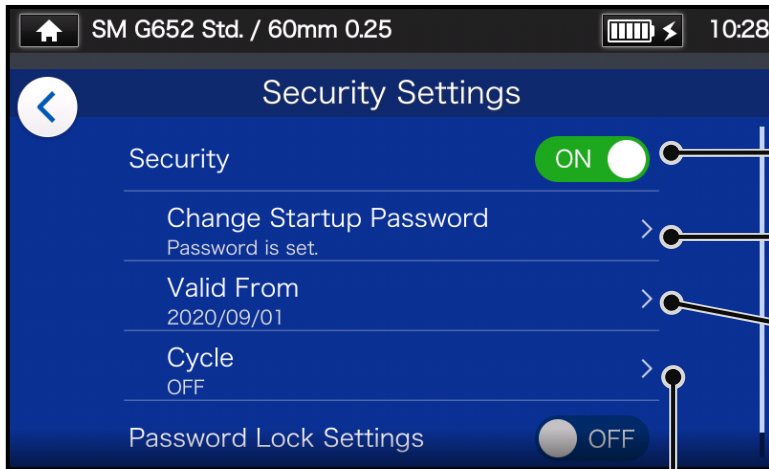

Security setting is enabled

Change a startup password

Change a date when the splicer requires a password entry.

Cycle setting



If you enable "Cycle" option, a startup password is requested every certain period of time (every day/every week/every month/every time) after the date when the startup password is activated passed.

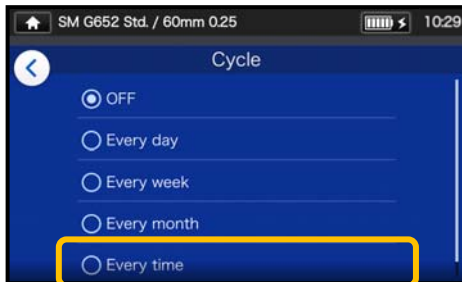

You cannot start the splicer if you've forgot the startup password. It should be taken notes of.
Please contact our maintenance service center if you've forgot it.

8. Administrator mode

● Lock the settings (all)

An administrator can lock various settings so an operator cannot edit them.



1: Open the Administrator settings panel. Tap "Password Settings".

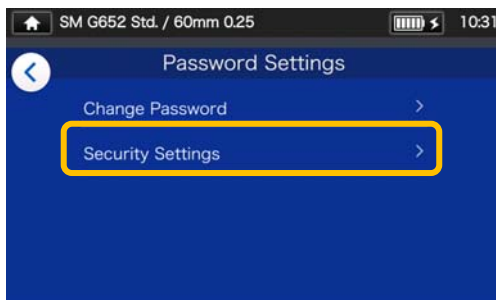

2: Tap "Security Settings".

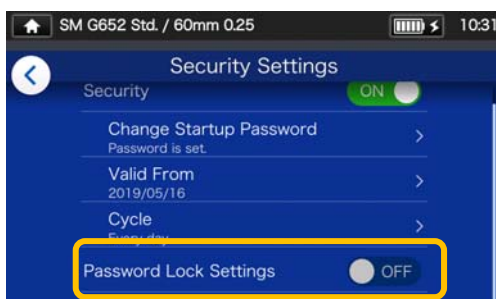

3: Scroll down the page, and then tap "Password Lock Settings" to set it to ON.

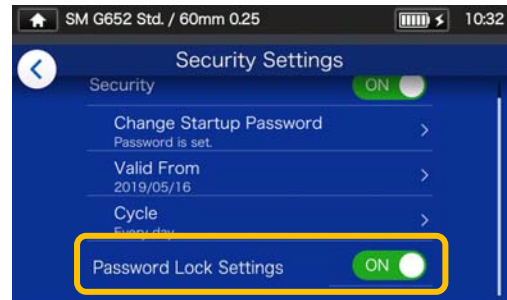

4: In Operator mode, splice program, heater program, function settings and sound setting cannot be edited.

If you would like to edit the settings after you've locked them, log in to Administrator mode, and then set "Function Lock Setting" to OFF.

You cannot start the splicer if you've forgot the startup password. It should be taken notes of. Please contact our maintenance service center if you've forgot it.

8. Administrator mode

● Lock the settings (individual)

An administrator can lock various settings on item by item basis so an operator cannot edit them.

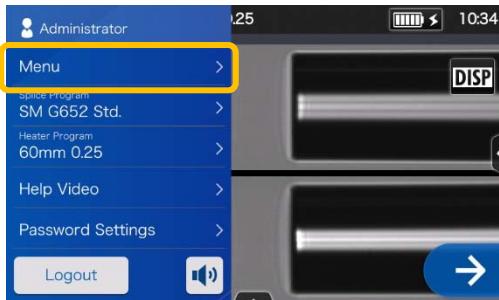

1: Open the Administrator settings panel. Tap "Menu" (Menu).

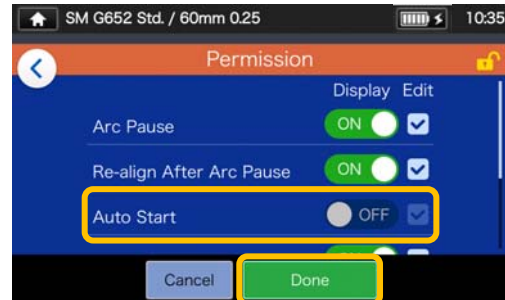

4: Toggle off an item, and then tap "Done" (Done). This example shows "Auto Start" is toggled off.

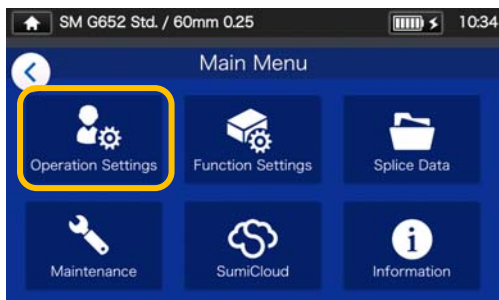

2: From the Menu screen, select "Operation Settings".



5: The lock setting is completed. After you log out of Administrator mode, the item which has been locked becomes hidden. In this example "Auto Start" is not shown on the Settings screen.



3: Tap the lock icon (🔒).

9. Troubleshooting

This chapter covers examples of troubleshooting and the solutions to error messages shown in the screen. If your problem is not solved by these troubleshooting and solutions, please contact our maintenance service center described in the back cover. Our maintenance service center also provide repair support for fusion splicers.

● Arc problems

The electrodes typically need replacement after **6,000 splices**. Some common symptoms that indicate the electrodes need replacing are:

- High or inconsistent splice losses
- Bubbles in the fibers after splicing
- Diameter faults
- Fluttering or unstable arc observed on the monitor
- Fiber burned in half
- Sizzling noise while arcing

Refer to page 3-5, "Electrode replacement".

If an electrode tip touches something, it will be deformed, causing poor arcing problems. Take care of the handling of electrodes.

● Fiber breakage

When the splicing process is complete, a proof test may be performed on the fibers while in the fiber chucks. If the fibers are broken when the proof test is performed, re-do an arc test. If the arc power level is too weak, the splice may be poor, resulting in fiber breakage.

If the fibers are breaking in spite of a good arc test result, clean the V-grooves and the bare fiber pads completely. Deterioration of a jacket remover/fiber cleaver may lead to fiber breaking. Clean the jacket remover/fiber cleaver completely.

● Splicer is not turned on

If the fusion splicer fails to turn on when the ON key is pressed, check the following:





- Verify that the battery pack is installed in the module bay properly
- Verify that the power plug is seated properly (the power cord is connected to the AC adapter.)
- Verify that the LED of the AC adapter lights up.
- If using battery operation, ensure that the battery is fully charged.

If the splicer still does not power up after checking the above, contact our maintenance service center.

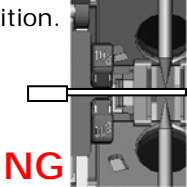
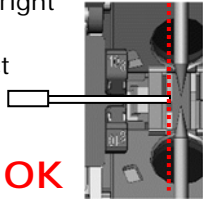
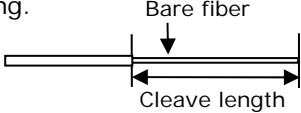

9. Troubleshooting

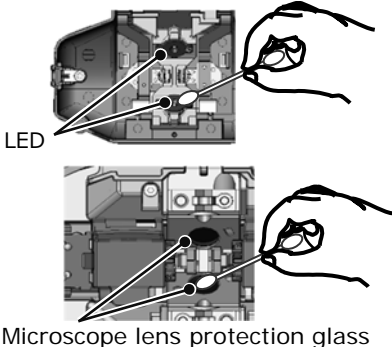
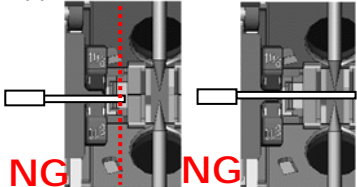
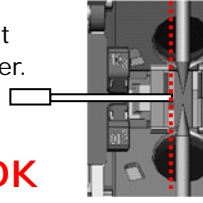
Error message list

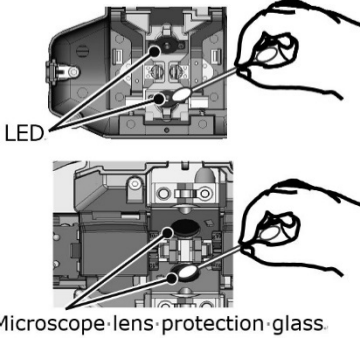



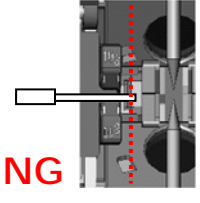
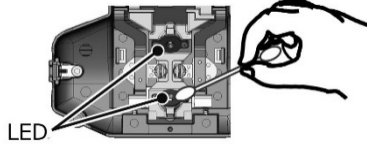
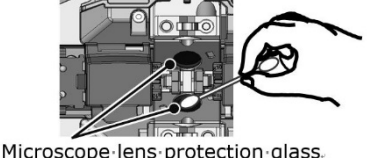
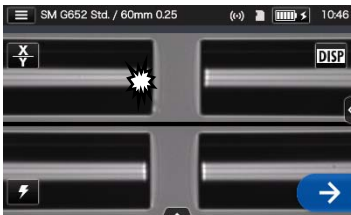

If you encounter any errors during use, please check the error message that appears and see the error message list below to troubleshoot.

Error message	Possible cause	Troubleshooting	Refer to
The splicer failed to adjust the LED brightness.	The fiber is loaded in a too forward position. 	Make sure that the right and left fibers are placed in the correct position of the splicer. 	▶P.2-14 Inserting fibers into the splicer
	Fiber cleave length is too long. Bare fiber 	When cleaving the fiber, make sure it is loaded in a correct position in the cleaver and cleave it to a correct cleave length.	▶Instruction manual that came with the cleaver you use.
	There is a foreign object in the screen. 	Clean the microscope lens protection glass and LEDs. 	▶P.3-2 Cleaning LEDs, P.3-3 Cleaning lens protection glass
The fibers are not placed correctly in the splicer.	The fiber is not loaded in an appropriate position. 	Make sure that the right and left fibers are placed in the correct position of the splicer. 	▶P.2-14 Inserting fibers into the splicer
	There is a foreign object in the screen. 	Clean the microscope lens protection glass and LEDs. 	▶P.3-2 Cleaning LEDs, P.3-3 Cleaning lens protection glass

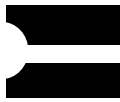

9. Troubleshooting

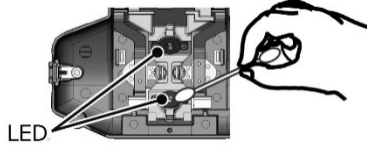
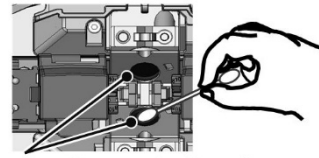
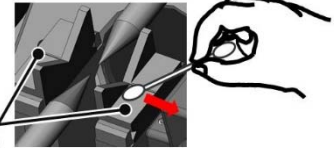
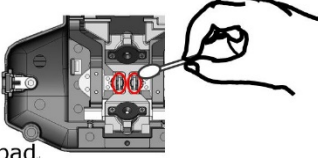
Error message	Possible cause	Troubleshooting	Refer to
The splicer could not detect the left (right) fiber.	The fiber is not loaded in an appropriate position.	Make sure that the left (right) fiber is placed in the correct position of the splicer. 	▶P.2-14 Inserting fibers into the splicer
		There is dust on the V-groove and bare fiber pad.	
The splicer failed to adjust the arc gap of the left (right) fiber.	There is a foreign object in the screen.	Clean the microscope lens protection glass and LEDs.  	▶P.3-2 Cleaning LEDs, P.3-3 Cleaning lens protection glass
		There is dust on the V-groove and bare fiber pad.	
The cleave angle of the left (right) fiber exceeds the allowable limit.		Cleave the left (right) fiber again. 	▶Instruction manual that came with the cleaver you use.



9. Troubleshooting

Error message	Possible cause	Troubleshooting	Refer to
A lip is observed on the left (right) fiber end.		Cleave the left (right) fiber again. 	▶ Instruction manual that came with the cleaver you use.
A chip is observed on the left (right) fiber end.		<ul style="list-style-type: none"> • Cleave the left fiber again and clean the cleaver. • If the fiber end face is still poor. Please change the blade position or replace the blade. 	▶ Instruction manual that came with the cleaver you use.
The splicer failed to adjust the focus.	There is a foreign object in the screen.	Clean the microscope lens protection glass and LEDs.  LED  Microscope lens protection glass	▶ P.3-2 Cleaning LEDs, P.3-3 Cleaning lens protection glass
	There is dust on the V-groove and fiber clamp.	Clean the V-groove and bare fiber pad.  V-groove  Bare fiber pad	▶ P.3-1 Cleaning V-grooves, P.3-2 Cleaning bare fiber pads
	There is dust on the fiber.	Cleave the left (right) fiber again.  Dust  OK	▶ Instruction manual that came with the cleaver you use.

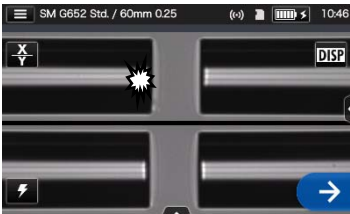
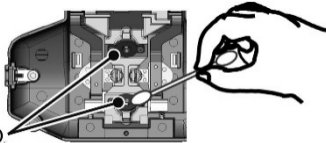
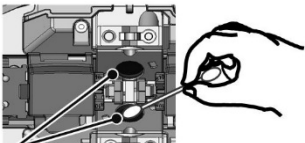
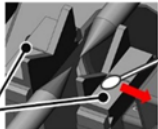
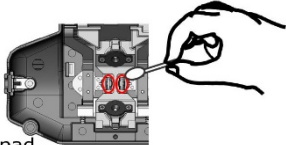
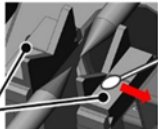
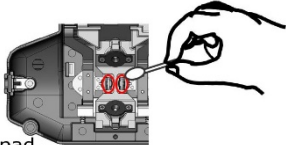
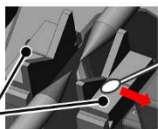
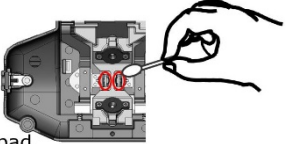
9. Troubleshooting

Error message	Possible cause	Troubleshooting	Refer to
The splicer failed to align the left (right) fiber. ▶Continued to the next page.	There is dust on the fiber.  Dust	Cleave the left (right) fiber again.  OK	▶Instruction manual that came with the cleaver you use.
▶Continued from the previous page. The splicer failed to align the left (right) fiber.	There is a foreign object in the screen. 	Clean the microscope lens protection glass and LEDs.  LED  Microscope lens protection glass.	▶P.3-2 Cleaning LEDs, P.3-3 Cleaning lens protection glass
	There is dust on the V-groove and bare fiber pad.  V-groove  Bare fiber pad.	Clean the V-groove and bare fiber pad.  V-groove  Bare fiber pad.	
The splicer failed to inspect the right and left fibers. ▶Continued to the next page.	There is dust on the V-groove and bare fiber pad.	Clean the V-groove and bare fiber pad.  V-groove  Bare fiber pad.	▶P.3-1 Cleaning V-grooves, P.3-2 Cleaning bare fiber pads

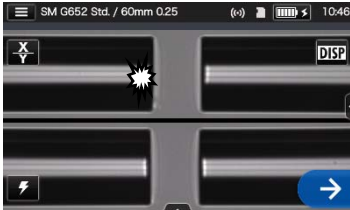
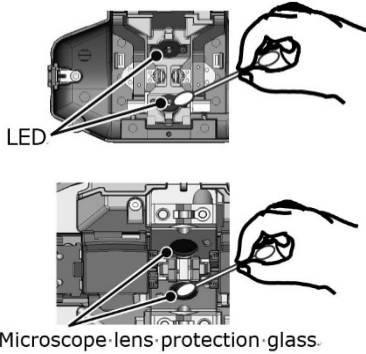
9. Troubleshooting

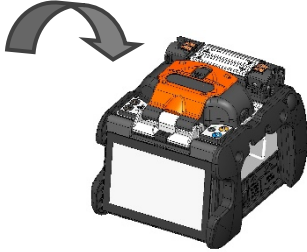
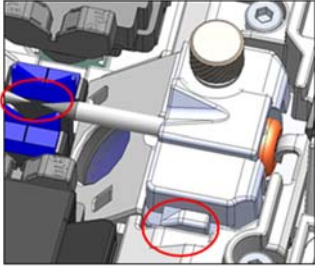
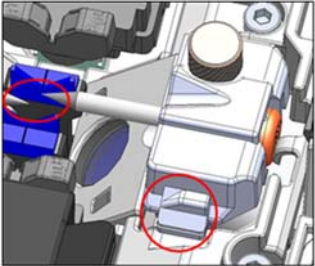
Error message	Possible cause	Troubleshooting	Refer to
	<p>There is a foreign object in the screen.</p> 	<p>Clean the microscope lens protection glass and LEDs.</p>  <p>LED</p> <p>Microscope lens protection glass.</p>	<p>▶P.3-2 Cleaning LEDs, P.3-3 Cleaning lens protection glass</p>
<p>▶Continued from the previous page. The splicer failed to inspect the right and left fibers.</p>	<p>There is dust on the fiber end face.</p> 	<p>Cleave the left (right) fiber again.</p> 	<p>▶Instruction manual that came with the cleaver you use.</p>
<p>The splicer is unable to start splicing because the hood is open.</p>		<p>Close the hood.</p> 	
<p>Unstable arc (Splice)</p>	<p>The electrodes are installed incorrectly in the splicer.</p>	<p>Make sure the electrodes are installed correctly in the splicer.</p> <p><Correct></p>  <p><Incorrect></p> 	<p>▶P.3-6, 3-7 Electrode replacement procedures</p>

Warranty and repair service

Repair and warranty

Before requesting a repair, determine the possible cause and do some troubleshooting referring to Page 9-1~P.9-6.

If the problem still persists, stop using the splicer and contact our maintenance service center.

REGION LIMITATION

This product is sold for the use in a limited sales area (refer to the information which appears on the splicer screen) and the technical support of the product moved out of the said region may be refused or require extra charges.

Warranty period

About the warranty period of this product, please ask to the distributor that you purchased the product from.

Services after warranty period

After the warranty period expires, all products may be repaired for a reasonable service charge.

The following cases are the exception for repairing and replacing the product free of charge.

- (a) Damage or malfunction caused by misuse, mishandling, non qualified repair, disassembly, modification, or any other irregular execution
- (b) Damage or malfunction caused by drop, fall or any other faulty treatment such as to be explained in precautions on this manual.
- (c) Damage or malfunction caused by actions that are beyond Sumitomo's control including for example, fire, water flood, earthquake, lightening or similar disaster, or any other accident.
- (d) Damage or malfunction caused by the use of Product in conjunction with accessories, products, or consumables not specified or approved by Sumitomo.
- (e) Replacement of consumables
- (f) Travel expense that is charged if a trip for repair is requested by the customer.
- (g) Damage or malfunction caused by use of batteries and battery chargers not specified or approved by Sumitomo.
- (h) Products founds corroded due to exposure to water or dew condensation, or cracked or deformed circuit board.

The customer shall bear the cost of returning the product to Sumitomo.

Contact Address

Tokyo (JAPAN)

**Sumitomo Electric Industries, Ltd.
(Global Business Dept.)**

Akasaka Center Building, 1-3-13,
Motoakasaka, Minato-ku, Tokyo
107-8468, JAPAN

Tel: +81 (0)3 6406 2666

<http://global-sei.com/sumitomo-electric-splicers>

North Carolina (U.S.A)

Sumitomo Electric Lightwave Corp.

201 South Rogers Lane, Suite 100

Raleigh, NC27610 U.S.A

Toll Free No. 800 358 7378

Tel: +1 919 541 8100

<http://www.sumitomoelectric.com>